

Product Introduction

There are now more than 600 types of agricultural chemicals introduced on the market in the world, including pesticides, bactericides, herbicides, rodenticides, nematicides, molluscides, plant growth regulators, and others. Among them, pesticides cause the greatest harm to the human body. Organophosphorus and Carbamates are the two most toxic pesticides for they have neurotoxicity despite their effectiveness in killing insects. The theory of Speedy Biochemical Method used by Accutest is based on highly-susceptible AChE testing to examine the total toxicity of highly toxic Organophosphorus and Carbamates. Accutest detects the inhibition of the enzyme acetylcholinesterase (AChE) from vegetables and fruits. The higher the inhibition rate, the higher the total toxicity of agricultural chemical residues.

Table of Contents

1. General information

- 1-1 Standard equipment.....3
- 1-2 Specifications5
- 1-3 Meter characteristics7
- 1-4 Guideline of operation safety8

2. Functional settings

- 2-1 Date and time.....9
- 2-2 Temperature scale11
- 2-3 Beeper function12

3. Before doing the test13

4. Preparation of the samples

- 4-1 Leaves14
- 4-2 Rhizome14
- 4-3 Vegetables/Fruits for juice15

5. Testing procedures

- 5-1 Turning on the meter20
- 5-2 Control test.....21
- 5-3 Sample test24
- 5-4 Understanding the test results ..27

6. Meter memory

- 6-1 Browsing meter memory28
- 6-2 Deleting meter memory30

7. Commonly used pesticides.....32

8. Important Information33

9. Specifications37

10. Important information38

1. General information

This instruction manual includes safety information and warnings. Please read through in detail and adhere to all the warnings.

Caution:

Before using this instrument, please be sure to read "guidelines of operation safety."

1-1 Standard equipment

After unpacking, please check the equipment and supplies based on the packing list. If you find supplies missing or broken parts, please contact our customer service department immediately for exchange. The instrument package and its accessories are listed below:

Package Contents

Accutest Meterx 1
CD User Manual.....x 1
Quick Guide.....x1
AAA Battery.....x 4

Optional Equipment:

30 Accutest strips package
Power adapter
Buffer solution



1-2 Screen Display

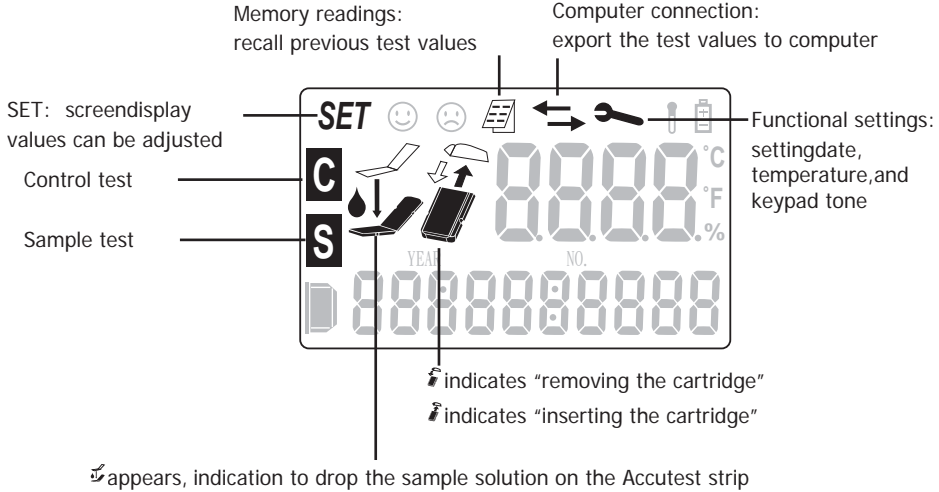

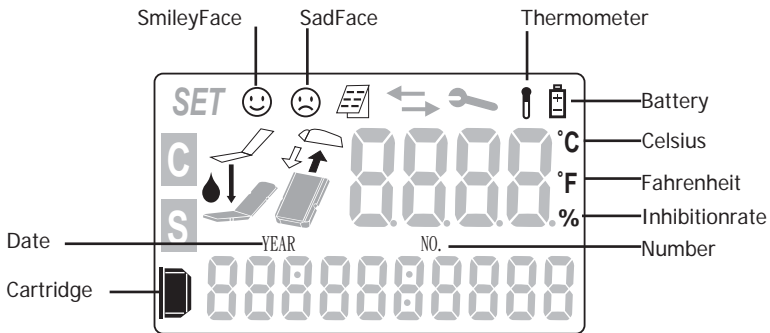

1-3 Meter Characteristics

- Items to be tested: vegetables, fruits, rice, corn and crops, organic fruits and vegetables, materials for Chinese medicine.
- Users: Purchasers of vegetables and fruits, wholesalers, hotels, schools, restaurants, companies, community welfare committees, families, individuals, and any units that need to examine agrochemical residues.
- Testing time: 10 minutes to prepare samples, 3 minutes for testing, the result in % inhibition will appear on the LCD display.
- Easy to preserve: Accutest strips can be preserved for 3~6 months when keeping the strips in a dry environment with dry agent, and sealed container.
- Testing modes: Control test and sample test.
- Easy to operate: Requires little or no training to use the Accutest Enzyme Inhibitor Testing Solution.

- LCD display: Large LCD display for inhibition rate, test procedure, and meter status.
- Internal memory: Stores up to 320 sets of memory.
- PC link (Optional): Export data to PC with specially designed software.
- Control testing: A control group serves as a comparison standard to ensure the accuracy of testing results.
- Temperature recording: Current temperature of operation can be recorded to ensure the accuracy of testing results.
- The Accutest meter be power by AAA batteries, or AC power adapter.

1-4 Guideline of operational safety

- Please note power voltage used must be the same as specified.
- This meter is based on precision optics, please do not plug or unplug power supply (when using AC power) while the meter is on. Error in operation may cause damage to the meter.

2. Functional Setting

2-1 Set Date and time





Note:

Accutest automatically memorizes test results with testing date and time. It is recommended to set the correct date and time prior to the testing, so that correct test date and time can be stored in the meter memory.









1. Press and hold the Enter key to turn on the meter. "Test" will appear on the LCD screen and show "Good" when the meter is turned on successfully. Press "Up down key" until "Function key" flashed and press "enter"

The main screen will show up on the screen. Press ▲▼ until the Function Setting icon flashes. Press Enter 



2. Use the ▲▼ arrow key until the year-month-date appears, then press  enter to confirm.
3. When set shows up on the upper left corner of the LCD screen, the year will flash.
4. Press ▲▼ to set the correct year. Press  to confirm.
5. Press ▲▼ to set the correct month. Press  to confirm.
6. Press ▲▼ to set the correct date. Press  to confirm.









7. Press ▲▼ until hh:mm:ss time appears then press Enter  to confirm.
8. SET will show on the upper left corner of the LCD screen.
9. Press ▲▼ to set the correct hour. Press  to confirm.
10. Press ▲▼ to set the correct minute. Press  to confirm.
11. Press ▲▼ to set the correct second. Press  to confirm.
12. Press ▲▼ until the  appears on the screen
13. Press  key until  flashes.
14. Press ▲▼ key until only the  flashes, then press  to return to the main menu.

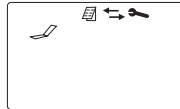

2-2 Set temperature scale (Celsius or Fahrenheit)







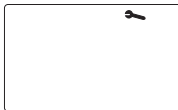



1. Press and hold the Enter key to turn on the meter. "Test" will appear on the LCD screen and show "Good" when the meter is turned on successfully. Press ▲▼ until  flashed and press "enter"



2. Press ▲▼ until the Function Setting icon flashes. Press Enter .
3. Press ▲▼ until the temperature appears and "SET" shows up on the upper left corner of the screen.
4. Press  to switch between Celsius and Fahrenheit
5. Press  until  flashes.
6. Press ▲▼ until  flashes, then press  to return to the main menu.



2-3 Beeper function

1. Press and hold the  to turn on the meter. "Test" will appear on the LCD screen and show "Good" when the meter is turned on successfully. Press   until  flashed and press "enter"
2. Press   until the "BEEP" appears and "SET" shows up on the upper left corner of the screen.
3. Press "enter key" to switch between On and Off.
4. Press   until only the  appears on the screen.
5. Press  to exit and return to the main menu

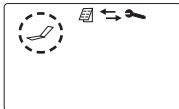
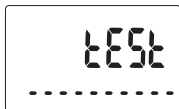

3. Before doing the test

Preparation of the buffer solution

1. Add distilled or cooled boiled water of the buffer powder till 100ml, and shake accordingly.



Note:

- It is natural for the buffer agent to agglomerate under room temperature, please do not be alarmed.
- Liquid form buffer solution can be stores for 8 months.
- Keep away from children.

4. Preparation of the samples

The sampling method of vegetables and fruits is to sample the edible parts as instructed below:

4-1 Leaves

1. Take two slices of vegetables leaves, and cut an area of 6cm^2
2. Place 2 pieces of 6cm^2 sample leaves into a container, such as paper cup
3. Add 6ml of buffer solution into the sample container using the large pipette(3ml). Large pipette is 3ml, you will need to use the large pipette twice. Let the sample and buffer solution sit for 10min

4-2 Rhizome

1. Take two slices of vegetables leaves, and cut an area of 6cm^2
2. Place 2 pieces of 6cm^2 sample leaves into a container, such as paper cup
3. Add 6ml of buffer solution into the sample container using the large pipette(3ml). Large pipette is 3ml, you will need to use the large pipette twice. Let the sample and buffer solution sit for 10min

4-3 Vegetables/fruits that make juice

1. Squeeze or blend the vegetable/fruit to extract the juice. Add two to three drops of the juice into a suitable container, such as a paper cup.
2. Add 6ml of buffer solution into the sample container using the large pipette(3ml). Large pipette is 3ml, you will need to use the large pipette and add twice. Let the sample and buffer solution sit for 10min

Note:

- Vegetables with edible viscous agents, such as yam, green onion, garlic, onion, mushroom, scallion, gumbo, and others, should not be cut into pieces or blended to extract juice for sampling, for this can result in false-positive error, or overestimating pesticide residues.
- Vegetables and fruits filled with natural colorants, such as mulberry, blueberry, carrots, and others, should not be cut into pieces or blended to extract juice for sampling, for this can cause confounding.
- Citrus vegetables and fruits high in acidity, such as lemon, strawberry, and others, only requires 50c.c. of cold water in the buffer solution. The testing method is the same as the Ch.4-3.

Note:

- Vegetables and fruits filled with water, such as watermelon, orange, and others, should be peeled before sampling.
- The skins of citrus fruit, including tangerine, orange, Sunkist, pomelo, kumquat, and others, include plant derivatives, which can cause false-positive error meaning overestimate the results.

Samplingmethod	Ordinarysampling		Specialsampling (extractingjuice)
Typesofveg- etablesand fruits	Use scissors to cut vegetable samples (2 pieces with 2.5cm length and width)	Use craft knife to slice off a vegetable sample (1 piece with 2.5cm length and width)	Extract two drops of samples into the buffer solution)



Samplingmethod	Ordinarysampling		Specialsampling (extractingjuice)
Leafy vegetables	Cabbage, broccoli, Chinese mustard, edible rape, spinach, lettuce, leafy sweet potato, leaf mustard, Basil, Garland chrysanthemum	Slice off the flower on the surface of Broccoli	
Fruitsand vegetables		Slice off the surface of egg plant and sweet pepper or corn granules	Extract two drops of tomato juice
Cucurbitveg- etables		Slicing off sampling pieces of pumpkin, Balsan pear (bitter gourd), Luffa (sponge gourd), cucumber ,wax gourd, bottle gourd (calabash gourd)	

Samplingmethod	Ordinarysampling	Specialsampling (extractingjuice)
Legumes	Peel the skins of peas, kidney beans, soy beans, green beans, and lima beans, and extract bean curd for sample testing	
Rhizome	Peel off the skin and cut off the edible part of carrot, yam, water bamboo, potato, taro, bamboo shoot, asparagus, and burdock for sample testing	

Samplingmethod	Ordinarysampling	Specialsampling (extractingjuice)
Fruits	Peel off the skin and cut out the edible part of apple and banana for sample testing	Peel the skin and extract the juice of citrus fruit (including tangerine, orange, Sunkist, pomelo, kumquat), litchi, longan, melon or fruit (including papaya, watermelon, cucumis melon, muskmelon, Cantaloupe, melon, pear, peach, plum, loquat, passion fruit, jujube, coconut)





5. Testing procedures

5-1 turning on the meter

1. Make sure the AC power supply is plugged in, or there are batteries in the battery compartment.
2. Press and hold the  key to turn on the meter. "Test" will appear on the LCD screen and show "Good" when the meter is turned on successfully. Press "Up down key" until "Function key" flashed and press "enter"
3. The main screen will show up on the screen. The Test Strip icon  flashes .



5-2 Control Test

1. After the meter is turned on successfully, press ▲▼ until the Test Strip icon  flashes. Press Enter  to enter the testing mode.
2. Press ▲▼ until the letter "C" (for Control) flashes.
Press Enter  to enter the Control test mode.
The current temperature will appear on the screen, together with icon  to indicate you may proceed to the next step.

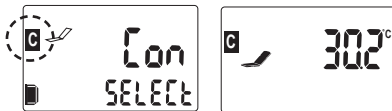

3. Unseal the test strip

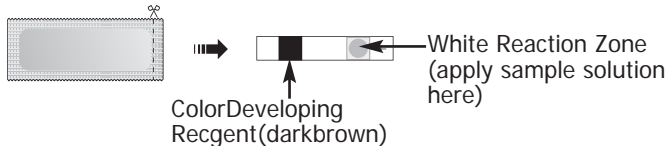

4. Place the test strip in the black foldable cartridge. The arrow sign on the test strip must be on top of the arrow sign on the cartridge.

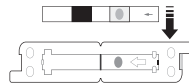

5. Using the small transfer pipette, add 3 drops of the buffer solution on the white reaction zone the one on the side of the sign. arrow

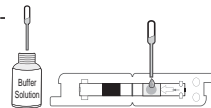

Note:

Make sure the buffer solution cover the whole reaction zone.

6. Press  the meter will start 60 seconds count down.

Note:

If the cartridge is inserted before the 60 seconds countdown is completed.

The message "PULL out" will appear on the screen to indicate you've made a mistake in running the test.

Please remove the test strip cartridge from the meter and repeat the test from step 3.

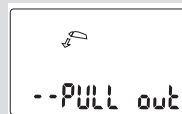

7. The meter will beep when the 60 seconds countdown completes. Fold the cartridge and insert the cartridge into the meter within 15 second. The meter will perform a 15 second count down to ensure you insert the cartridge into the meter within 15 second

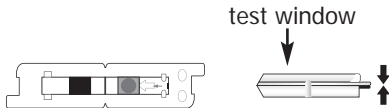

Note:

- If the foldable cartridge is not inserted into the strip cartridge port during the 15 seconds countdown, the meter will give an error message "Err". Press any button and redo the test from step 3.
- Please do not touch or move the cartridge during the testing.

8. The meter will start to run the test. Messages "CAL1" and "CAL2" will appear on the screen, followed by the 180 seconds countdown.

9. The meter will beep when the 180 seconds countdown completes. The message "GET" will appear on the screen to indicate the control test is done. Pull out the cartridge. Press Enter (↵) to return to the testing mode screen. You may proceed to the sample test now.



5-3 Sample Test

1. Press ▲▼ until the letter "S" (for Sample) flashes.

Press Enter  to enter the Sample test mode. The current temperature will appear on the screen, together with icons to indicate you may proceed to the next step.

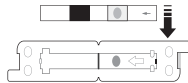

2. Place the test strip in the black foldable cartridge. The arrow sign on the test strip must be on top of the arrow sign on the cartridge.

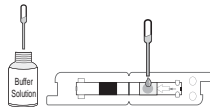

3. Using the small transfer pipette, add 3 drops of the buffer solution on the white reaction zone the one on the side of the sign. arrow

Note:

Make sure the buffer solution cover the whole reaction zone.

4. Press Enter  The meter will start 60 seconds count down.

Note:

If the cartridge is inserted before the 60 seconds countdown is completed.

The message "PULL out" will appear on the screen to indicate you've made a mistake in running the test.

Please remove the test strip cartridge from the meter and repeat the test from step 3.

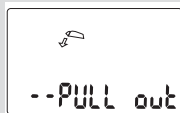

Note:

- Make sure the sample solution cover the whole reaction zone.
- Make sure to maintain the cleanliness of the white reactive area.

5. Press Enter  The meter will start 60 seconds countdown.

Note:

If the cartridge is inserted before the 60 seconds countdown is completed.

The message "PULL out" will appear on the screen to indicate you've made a mistake in running the test.

Please remove the test strip cartridge from the meter and repeat the test from step 2.

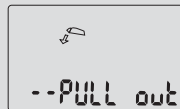

6. The meter will beep when the 60 seconds countdown completes. Fold the cartridge and insert the cartridge into the meter within 15 second. The meter will perform a 15 second count down to ensure you insert the cartridge into the meter within 15 second



Note:

If the foldable cartridge is not inserted into the strip cartridge port during the 15 seconds count down, the meter will give an error message "Err". Press any button and redo the test from step 2.





7. The meter will start to run the test. Messages "CAL1" and "CAL2" will appear on the screen, followed by the 180 seconds countdown.
8. The meter will beep when the 180 seconds countdown completes. The test result will appear on the screen. The meter will automatically save the test result, together with testing date, time, temperature, and test sequence number in the memory. Pull out the cartridge. Press  to return to the testing mode screen. You may repeat the test from step 1.

Note:

- Please do not touch or move the cartridge during the testing.
- The screen will show "HI" when the test result is higher than 85%, and "LO" when the test result is lower than 15%.

Note:

- When you finish all the sample testing, press ▲▼ until both the letters "C" and "S" appear next to the Test Strip icon. Press Enter  to return to the main screen.
- You can turn the meter off by pressing and holding Enter .
- The meter automatically turns off after 3 minutes of idling.



5-4 Understanding the test results

When the test result is higher than 40%, it is likely the sample contains pesticide residual. It is advised to wash the tested sample and redo the test again.

6. Meter Memory

Accutest meter provides memory function. The meter can store up to 320 test results.

6-1 Browsing the meter memory.

1. Press and hold the Enter key to turn on the meter. "Test" will appear on the LCD screen and show "Good" when the meter is turned on successfully. Press ▲▼ until  flashed and press "enter"
2. The main screen will show up on the screen. Press ▲▼ until the Memory icon flashes. Press  .
3. The latest test result together with testing time and testing sequence number will appear on the screen.
4. Press ▼ to view the previous result. Press ▼ again to view the result before that, and so on. The oldest test result has the testing sequence number 001.

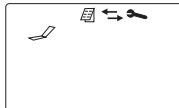

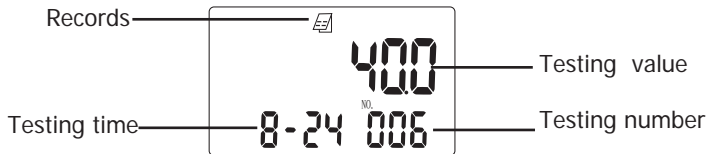

5. Press ▲ to go back to the most recent test result.

6. Press □ to show the testing date of the test record. Navigate between the test records by pressing ▲▼ as step 3 and 4.



7. Press □ to show the testing temperature of the test record.

Navigate between the test records by pressing ▲▼ as step 3 and 4.

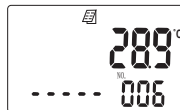



8. Press □ to return to the main screen.

6-2 Deleting the meter memory

1. Press and hold the  to turn the meter on. "TEST" will appear on the screen.

".....Good" will appear on the screen in about 10 seconds to show that the meter is turned on successfully

The main screen will show up on the screen. Press   until the Function Setting icon flashes. Press Enter .

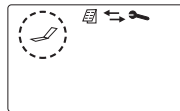
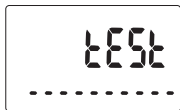

2. Press  until the Delete Memory screen appears, where "Out" and the number of memorized records on the screen and the Memory icon flashes.





3. Press  to indicate you wish to delete all the records. The screen will show the message "Clear" and the number of records in the memory.

Note:

If you do not wish to delete the memorized records, press Enter after step 3 will take you back to the Delete Memory screen. You may then press ▲ ▼ only the Function Setting icon appears on the screen and press Enter to exit and return to the main screen.







4. Press ▲ or ▼ to confirm the delete. The screen will show the message "Clear" and the number of record in the memory will become zero.
5. Press  to return to the Delete Memory screen.
6. Press ▲ ▼ until only the  Setting icon appears on the screen and press Enter to exit and return to the main screen.









7. Commonly used pesticides







Agricultural chemicals	Names	Scope of use
Organophosphorus	Dichlorvos, Methamidophos, Mevinphos, Parathion, Monocrotophos, Ethion, Dicrotophos, EPN, Disulfoton, Diazinon, Dioxathion, and Fenchlorphos	Leaf vegetables, melons, fruits, mushroom, legume, root vegetables, pear, rice, orange
Carbamates	Aldicarb, Carbaryl, Carbofuran, Methomyl, Mipc-Ethoprophos, Oxamyl, Propoxur	Leaf vegetables, melons, fruits, berries, orange, pear, rice, and

8. Signal illustration and explanation

The device will start light calibration upon powering-up. If the reflection value detected is within acceptance range, then a happy face will appear, or otherwise, the system will display a sad face when error is detected.

Control group	Sample group
 <p data-bbox="324 391 759 632">Enter the control mode after powering on. After 60 sec of reaction time, the system will enter a 15-sec countdown. If no cartridge is inserted, then the screen will display "Err"</p>	 <p data-bbox="956 391 1390 632">Enter the sample mode after powering on. After 60 sec of reaction time, the system will enter a 15-sec countdown. If no cartridge is inserted, then the screen will display "Err"</p>
 <p data-bbox="324 669 759 993">Enter the control mode with the cartridge inserted after 60 seconds of reaction time. If the cartridge is removed during the measurement and fails to be replaced within 15 seconds, then the screen will display "Err 2"</p>	 <p data-bbox="956 669 1390 993">Enter the sample mode with the cartridge inserted after 60 seconds of reaction time. If the cartridge is removed during the measurement and fails to be replaced within 15 seconds, then the screen will display "Err 2"</p>

Symbols	Explanations	Problem solving
	Battery low	Replace new battery and reset time
	Abnormal temperature (below 10°C or over 40°C)	Make sure the device is operating under a specified temperature range.
	Successful power-on	
	Abnormal power-on	Please restart the device. If a sad face still appears, please contact our customer service.
	Set-up mode	
	Data-transfer mode	
	Data-memory mode	
SET	Function-selection mode	
C	Enter the control-testing mode	
S	Enter the sample-testing mode	
	Remove cartridge	
	Apply control/sample on a test strip	
I	Please apply a drop of sample	

Symbols	Explanations	Problem solving
	Please insert the cartridge into the optic port	
	Insert cartridge	
	Remove cartridge	
	Warning that the cartridge is not yet inserted	
	Please place a strip on the cartridge	
	Please place a strip inside the cartridge	Wait for 60-sec reaction time to complete
YEAR	Year	
°C	Celsius	
°F	Fahrenheit	
Hi	Enzyme inhibition over 85%	If you question the testing result, please conduct a new test again.
Lo	Enzyme inhibition under 15%	

9. Specifications

Model	AccuTest
Light source	LED
Detection method	Reflectance
Measurement unit	% inhibition Rate
Detection range	15%~85%
Detection time	180s
Wavelength	615nm
Precession	+/- 3%
Working temp	10~40C (50~104F)
Internal memory	320sets
Display	52 x 32 mm LCD
Data output	USB
Power	100~240V DC 6 +/- 0/6V AAA battery x 4
Dimension	89.5(W) x 160(D) x 36.6(H) mm
Weight	0.16KG

*Metertech reserve the right to alter specifications without notice

10. Important information

- The meter has such functions as automatic numbering, inhibition rate calculating, and automatic test records storing. The meter can memorize up to 320 test results.
- Based on the principle of "what you test on is what you eat", focus on the edible part of sample when sampling. Please use samples processed on the same day.
- Please perform a control test after 24hr or the variation in environment temperatures is larger than 5 degrees.
- When you make buffer solution, cooled down boiled water must be used to mix with the buffer agent. Processed buffer solution can be preserved 8 months under room temperature (25°C or 77°F).
- Keep the meter and cartridge clean for accurate results
- Accutest Enzyme Inhibitor Testing Solution cannot test tea leaves. Tea leaves will give a false negative result
- Diazinon is generalized pesticide of Organophosphorus compounds, but it's thiophosphate group. Thiophosphate group would lead to obvious different sensitivity for the direct inhibition of acetylcholine activity compared with non-thiophosphate pesticide of Organophosphorus