

Operational Manual

UV/Visible Spectrophotometer
SP-8001



Metertech Inc.
Version 1.10

Metertech Inc. provides this publication "as is" without warranty of any kind, either express or implied, including, but not limited to the implied warranties of merchantability or fitness for a particular purpose.

All rights are reserved, including those to reproduce this publication or parts thereof in any form without permission in writing from Metertech Inc.

Information in this publication is subject to change without notice and does not represent a commitment on the part of the vender.

Any errors or omissions which may have occurred in this publication despite the utmost care taken in its production will be corrected as soon as possible, but not necessarily immediately upon detection.

Copyright© Metertech Inc. 1999

Metertech Inc. • 63-2 Cheng Gong Rd. Sec. 1 • Nangang, Taipei, Taiwan, R.O.C.

E-Mail: info@metertech-inc.com • Web Site: www.metertech-inc.com

Tel.: 886-2-2783-2854 • Fax.: 886-2-2783-1764

Contents

Chapter 1 Introduction	-----	4
§1-1 Specification	-----	4
§1-2 Safety Notes	-----	5
Chapter 2 Installation	-----	6
§2-1 Unpacking	-----	6
§2-2 Installation	-----	7
Chapter 3 General	-----	8
§3-1 User Interface	-----	8
§3-2 General Function Description	-----	10
§3-3 Initialization	-----	12
Chapter 4 System setup	-----	14
§4-1 System Setup Menu	-----	14
Chapter 5 Photometric	-----	19
§5-1 Photometric Parameter Setup	-----	19
§5-2 Photometric Function Structure	-----	20
§5-3 Basic Photometric Measurement	-----	20
Chapter 6 Spectrum	-----	24
§6-1 Spectrum Parameter Setup	-----	24
§6-2 Spectrum Function Structure	-----	25
§6-3 Basic Spectrum Measurement	-----	26
Chapter 7 Timescan	-----	31
§7-1 TimeScan Parameter Setup	-----	31
§7-2 TimeScan Function Structure	-----	32
§7-3 Basic TimeScan Measurement	-----	33
Chapter 8 Kinetic	-----	35
§8-1 Kinetic Parameter Setup	-----	36
§8-2 Kinetic Function Structure	-----	37
§8-3 Basic Kinetic Measurement	-----	38
Chapter 9 Quantitative	-----	40
§9-1 Quantitative Parameter Setup	-----	40
§9-2 Quantitative Function Structure	-----	41
§9-3 Basic Quantitative Measurement	-----	42
Chapter 10 Accessories	-----	45
§10-1 Multi-Cell Holder	-----	45
§10-2 Sipper	-----	47
Chapter 11 Maintenance	-----	49
§11-1 Routine Maintenance	-----	49
§11-2 Replacement of Lamps	-----	50
Appendix A Thermal Controller Operation Instruction	-----	52
Appendix B Sipper Operation Instruction	-----	54
Appendix C Setting of USB Serial Port	-----	57

Chapter 1 Introduction

The SP-8001 UV-VIS Spectrophotometer is an instrument designed and manufactured by Metertech Inc. It can meet the wide-ranging needs of prospective users. The main unit features fundamental photometric functions that are ready expandable using various application software packages and attachments for enhanced convenience and productivity. It is designed to be user-friendly and require as little engineering knowledge as possible to adopt in users' application.

In order to obtain maximum performance and trouble-free operation with the SP-8001, It is recommended that you carefully read this manual before using the SP-8001, and thereafter keep it close at hand for future reference.

§1-1 Specifications

Wavelength	190-1100nm
Bandwidth	<2nm
Wavelength accuracy	+/- 0.5nm
Monochromator	Split Beam (Internal double beam design)
Wavelength repeatability	+/- 0.2nm
Photometric range	-0.3000-4.5000A 0.01-300 %T 0.0000-44995C
Photometric accuracy	+/- 0.005Abs at 1.000Abs by NIST SRM930e
Stability	drifting < 0.0003Abs/hr at 500nm after 1 hour warm-up
Baseline flatness	+/- 0.001Abs (at 210-1000nm)
Stray light	< 0.05% at 340nm & 220nm by NIST SRM2031
Light source	deuterium lamp (UV range) & halogen lamp (Vis range)
Source lamp change	automatic
Detector	Silicon photodiodes
Wavelength scanning speed	100-5000nm/min (user-programmable)
Path-length	variable at 10-100 mm
Display	backlight LCD – adjustable contrast
Interface	serial & parallel
Power/fuse	AC input: 100/120/220/240V 50/60Hz, Fuse: T2A for 220/240V, T4A for 100/120V
Dimension	506(W)X430(D)X220(H)mm
Weight	18kgs
Ambient temp/humidity	room temperature 15-35°C, humidity < 80%

Specifications subject to change without notice.

§1-2 Safety Notes

Although this SP-8001 UV-VIS Spectrophotometer is user friendly, the instrument and its accessories described in this manual are designed to be used by properly trained persons only. **READ THIS SECTION CAREFULLY BEFORE INSTALLING AND USING THE INSTRUMENT AND ITS ACCESSORIES.**

Adjustment, maintenance, and repair of equipment must be carried out only by qualified persons who are aware of possible hazards involved. Wherever indicated in this manual, certain maintenance may be carried out by users, who must be fully understand and apply the following safety precautions.

For the correct and safe use of this instrument and its accessories it is essential that both operating and servicing persons follow generally accepted safety procedures in addition to the safety precautions specified in this manual.

Some of the chemicals used in spectrophotometer are corrosive, and/or flammable and samples may be radioactive, toxic or potentially infective. Care should be taken to follow the normal laboratory procedures for handling chemicals.

Only the persons who have been trained to avoid the risk of electric shock are qualified to remove the instrument covers and accessories. The mains electricity supply to the instrument must be disconnected at the mains supply connector and at least three minutes allowed for capacitors to discharge.

The UV radiation from a deuterium lamp can be harmful to the skin and eyes. Always view the lamp through protective glasses that will absorb the UV radiation and avoid looking directly at the deuterium arc. Do not expose the skin to direct or reflected UV radiation.

Whenever it is likely that safety protection has been impaired, the instrument and/or accessories must be made inoperative and secured against any unintended operation. The matter should then be referred to appropriate service authority.

Chapter 2 Installation

BEFORE installation please read safety notes in previous page carefully. Failing to abide by the regulations may cause damages to the instrument and may obtain incorrect results.

§2-1 Unpacking

The SP-8001 (Figure 2.1 and Figure 2.2) should be delivered with intact packaging that contains one carton with items listed in the packing list. Unpack the carton and inspect carefully. If any part is damaged or missing, contact your local dealer immediately.

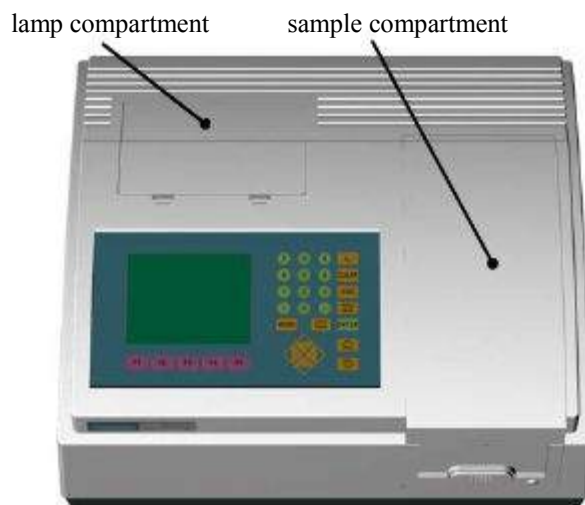

Figure 2.1 Top view of the SP-8001

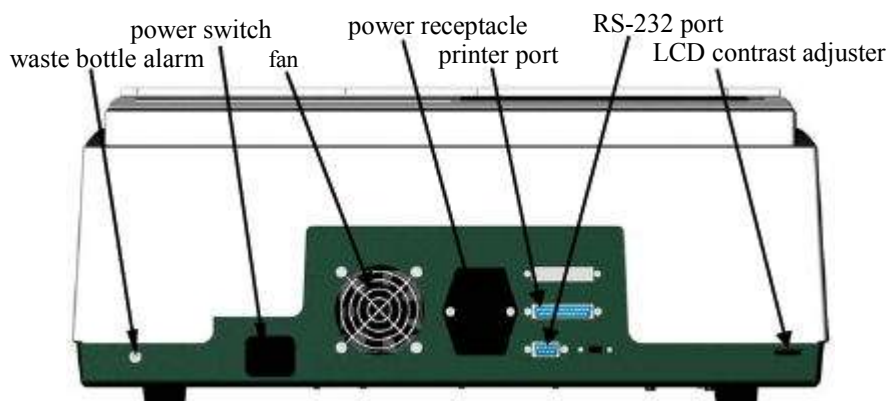

Figure 2.2 Back panel of the SP-8001

Save the carton with packing materials in a proper place in case that the instrument may need to be repacked or to be returned for service.

§2-2 Installation

Before the first installation, please inspect carefully whether any damages or suspicious defects you may be aware of. Do the followings before turn on the instrument. Contact your local agent for help if encountering any difficulties during installation and operation.

- A. Always place the instrument on a stable and vibration-free table. Allow two inches behind the rear panel of the instrument for air circulation and power cord, and protect the instrument from being located:
 - ◆ in direct sunlight
 - ◆ in drought from window, air conditioner or heater
 - ◆ near copy machine
 - ◆ near refrigerator or oven
 - ◆ near ultrasonic cleaner
 - ◆ near X-ray equipment
 - ◆ near centrifuge
- B. Check and set the voltage. The SP-8001 can be performed with selective power supply at 100, 120, 220, or 240Vac 50/60Hz from a properly wired and grounded single phase power outlet. Check the voltage shown in the frame above power inlet. If it is not the desired, use flat screw driver to open the protective plastic cover. Push inside the voltage wheel and turn it into the desired position accordingly. Close the protective plastic cover.
- C. The room temperature of operating site should be between 15 - 30°C, and humidity less than 80%.
- D. Install all desired accessories and connect necessary wires and tubes properly.
- E. Plug the power cord into the instrument inlet and to an appropriate wall outlet.
- F. Now the system is ready for performance. Turn power on and refer details of operation to specific sections.

Chapter 3 General

The SP-8001 is designed to be a self-contained instrument and can work as a standalone machine or can work with other peripherals together.

The SP-8001 has one membrane-type keyboard and a 320X240 LCD display as the user interface. User may key in data through the keyboard and proper messages will show on the display. A lamp compartment facilitates a tungsten halogen lamp and a deuterium lamp that users are allowed to replace those lamps whenever needed. READ SAFETY NOTES in section §1-2 carefully and instructions in section §11-2 before changing lamps. A sample compartment is the area for users manipulating their samples. Also it allows users to install proper accessories for specific operations.

§3-1 User Interface

The SP-8001 keyboard with LCD display module is shown in Figure 3.1. Operations of those keys are designed to be user friendly. In most of cases, users press keys according to instructions shown in the corresponding screens. Otherwise, refer to specific sections of different operation modes for more details.

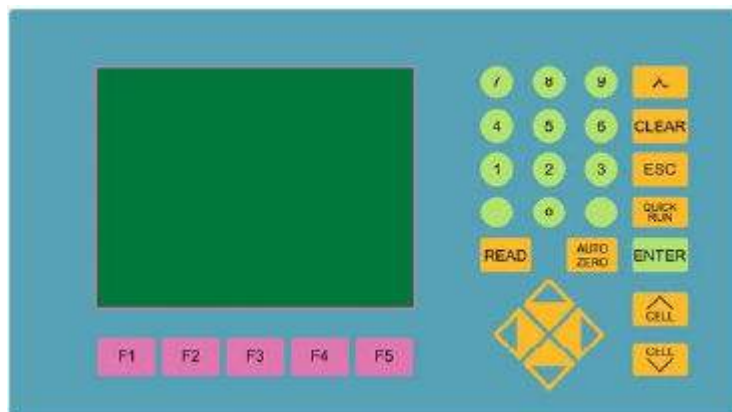

Figure 3.1 Keyboard with LCD display module

For operations with optional accessories, refer to proper sections in Chapter 10.

General explanation of keys is given below:

Function keys	Selecting and performing supporting functions shown in the screens.
Numerical keys	For entering numbers, minus, and decimal point
λ	For entering desired wavelength.
CLEAR	To clean up unwanted input digits in the entry field.
ESC	To quit the current screen and go back to the previous screen, or to quit from the current process, or to go back to upper level of function key screen.
QUICK RUN	To pop up a Parameter File List (Figure 3.2) for users to select operation settings

stored in memory. In this file list, users can view all parameter settings in different operation modes that is distinguished by the first 2 letters in the first column. For example, PH represents for "Photometric" mode. Filenames are shown in the second column, while the corresponding time in the third column.

READ

To start measuring process according to the current settings.

AUTO ZERO

To perform blank correction when needed. It sets the photometric value to 0ABS

12:00:00 QUICK RUN 500.0nm 0.000A				
Parameter file list				

No	Name	Time		
PH-02				
PH-03				
PH-04				
SP-05	HOLMIUM	07/12/99 09:30:12		
SP-06				
SP-07				
SP-08				
TS-09	LIGHT01	06/24/99 13:22:43		
TS-10	LIGHT02	06/25/99 15:32:33		
TS-11				
TS-12				
KI-13	GOT01	03/21/99 16:37:21		
KI-14				
KI-15				
KI-16				
Press UP DOWN key to select				

Figure 3.2 Quick Run Parameter File List screen

(100%T) after AUTO ZERO being pressed.

ENTER

To confirm selections or entries of fields or parameters.

Arrow keys

To move the cursor between entry fields or parameters.

Left/right arrow keys are also used for switching Yes/No as instructed.

CELL ^

To move sample holder one position up as needed.

CELL v

To move sample holder one position down as needed.

§3-2 General Function Description

Functions being used in the SP-8001 are listed in the corresponding modes and are shown in structured maps. For those functions being widely used in most of the modes will be described below.

Load Param For loading existing parameter settings stored in memory. When this function is pressed, a parameter file list screen (Figure 3.3) shows up and users can choose from the list by using arrow keys and followed by an ENTER key. Only the mode-relevant parameter setting files will appear when function Load Param is pressed.

Save Param For saving a current settings into memory. Filename is entered

12:00:00 PHOTOMETRIC 500.0nm 0.000A				
----- Parameter file list				
No	Name	Time		
02				
03				
04				
05				
06				
07				
08				
09				
10				
11				
12				
13				
14				
15				
Press UP DOWN key to select...				

Figure 3.3 Parameter file list in photometric mode

through a 4 by 9 array-type table (Figure 3.4). By using up/down arrow keys for choosing rows and then numerical keys for choosing column, the desired alphabet or number will be picked up. 10 alpha-numerical keys are the maximum for a filename. Using left arrow key to delete the input. An ENTER key will close the input procedure and the Parameter File List screen will show up. Using up/down arrow keys to choose a place for the filename and followed by an ENTER key will complete the Save Param procedure. A time tag will be automatically attached to the saved filename. Press function Load Param and you may see what has just been done.

Print Data To print data or graph from the current screen.

Sample Control To be functioning only when certain accessory being used.

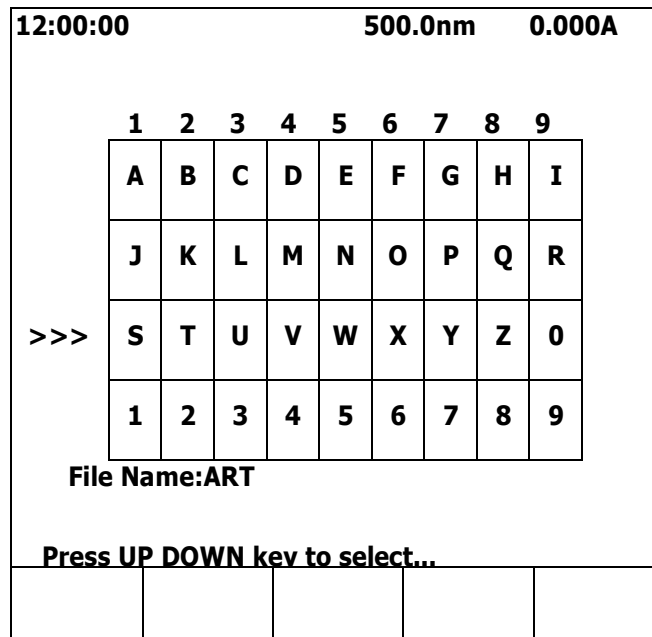

Figure 3.4 Filename input screen

Next Screen

Accept the current settings and switch into the measuring display screen. Once get the sample(s) ready, press READ for proceeding the measurement according to the setup. Sometimes, it is used for tracing back to the previous level of functions or for showing the previous graph on the screen.

Prev Screen

Leave the current display screen and switch back to a previous display screen.

Manipulate

For further manipulation of current data either from new measurement or from existing data files.

Clear Graph

To clean up the current screen. This will result in loss of data in previous measurement. Only those data for the most current measurement can be rebuilt with function Original under function Manipulate.

Load Data

To load data with determined parameter setup from the associated Data File List.

Save Data

To save the data of current measurement or to save the data of chosen point in function Show Track. This will also save the settings of parameters in that measurement. Message "No data present ..." will show if there is no data in the screen.

§3-3 Initialization

Turn on the power of the SP-8001, a start-up screen (Figure 3.5) shows up and the initialization of system will be automatically done. The version of software coming up with the instrument is also shown in the start-up screen. User-installed accessory will be automatically detected during the initialization.

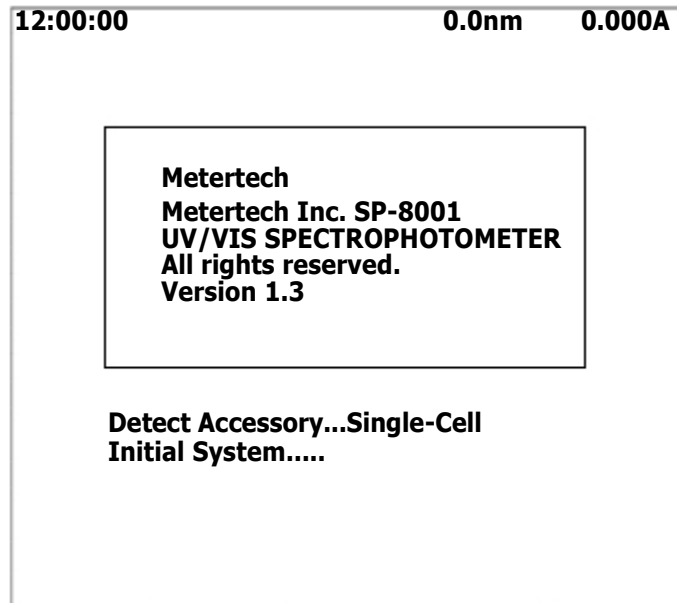

Figure 3.5 Start-up screen

Following the initialization, the System Main Menu screen will show up (Figure 3.6). Six items representing six operation modes are available for users to select as required. Users may use numerical keys or arrow keys, followed by an ENTER key, to complete the selection of desired mode.

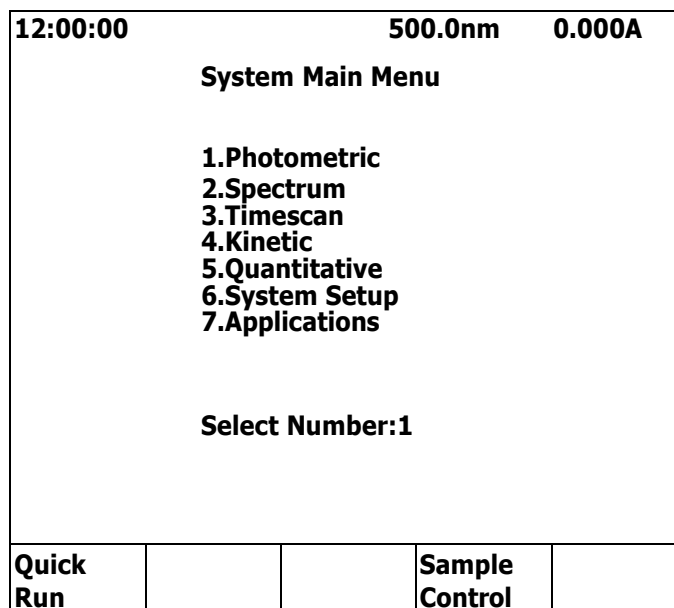

Figure 3.6 System Main Menu screen

Two functions, Quick Run and Sample Control, are available in this screen. Quick Run is a function the

same as described before by using the QUICKRUN key. Sample Control will be functioning only when the multi-cell holder or the sipper is used.

Chapter 4 System setup

In System Main Menu, selecting item 6 will get into the System Setup Menu screen (Figure 4.1). In this screen, users are allowed to alter several parameters described below. In this screen only one function, Load B-Line, is available.

12:00:00		500.0nm		0.000A	
System Setup Menu					
<ul style="list-style-type: none"> 1.Setup Clock 2.Setup Lamp 3.Setup Printer 4.Setup RS-232 5.Setup Hardware 6.Measure Bandwidth 7.Measure Base-line 8.Search Zero Position 					
Select Number:1					
Load B-Line					

Figure 4.1 System Setup Menu screen

Load B-Line

Will reload the results of Base-line measurement.

§4-1 System Setup Menu

Setup Clock

To set values (Figure 4.2) for Month, Date, Year, Hour, Minute, and

12:00:00		500.0nm		0.000A	
Clock Parameter Setup					
1.Month					:08
2.Date					:04
3.Year					:99
4.Hour					:15
5.Minute					:28
6.Second					:00
Number from 01 to 12...					
		Print Data		Prev Screen	

Figure 4.2 Clock Parameter Setup screen

Second as necessary.

Setup Lamp

Use function keys to set up parameters for visible and UV lamps (Figure 4.3). Switch UV is for switching ON/OFF of UV lamp. Reset Vis Hr is for resetting the usage time of the tungsten lamp. Reset UV Hr is for resetting the usage time of the UV lamp. Energy Vis is for

12:00:00		500.0nm		0.000A
Lamp Parameter Setup				
1.Visible lamp status			:ON	
2.Visible lamp used hours			:20	
3.Visible lamp energy			:100%	
4.UV	lamp status		:ON	
5.UV	lamp used hours		:20	
6.UV	lamp energy		:100%	
Switch UV	Reset Vis Hr	Reset UV Hr	Energy Vis	Energy UV

Figure 4.3 Lamp Parameter Setup screen

measuring the power of the tungsten lamp. Energy UV is for measuring the power of the UV lamp.

Setup Printer

Four printers (SII DPU-41X, Epson 9/24 Pin, Epson Stylus and HP Deskjet/Laserjet) can be selected through arrow keys as instructed (Figure 4.4).

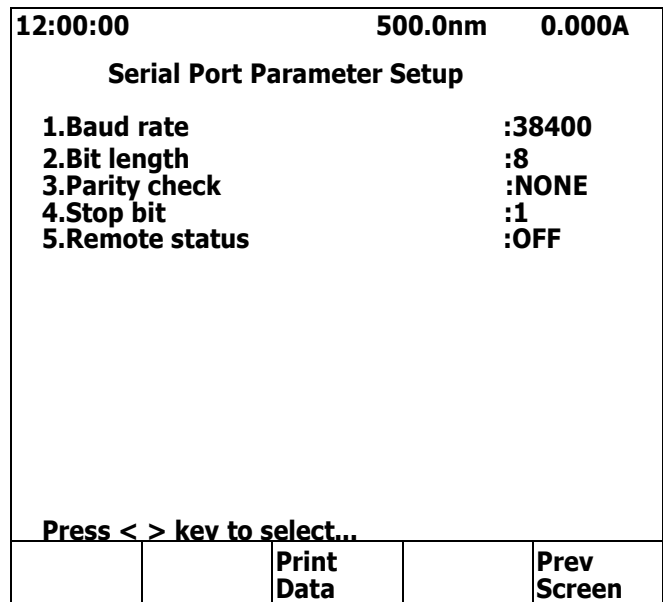

Figure 4.5 Serial Port Parameter Setup screen

Setup RS-232

Parameters for RS-232 can be set up through instructions shown in the screen (Figure 4.5).

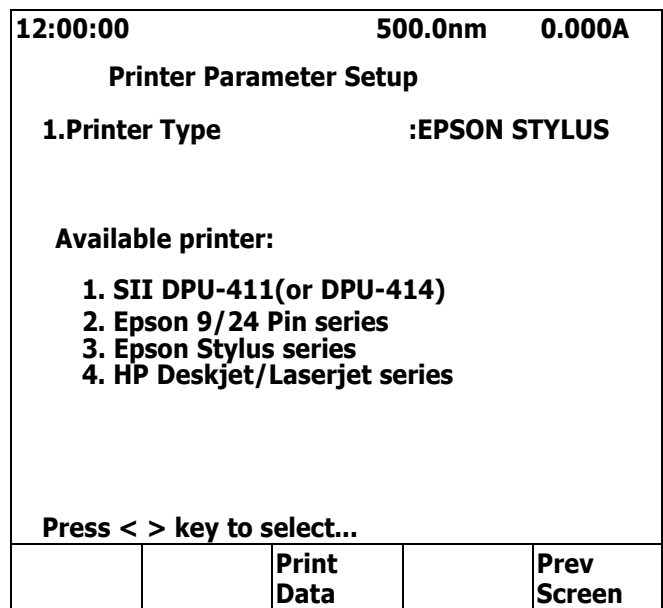

Figure 4.4 Printer Parameter Setup screen

Setup Hardware

In this option, three adjustable items are shown (Figure 4.6). Use arrow keys to move cursor to proper position and proceed as instructed at the bottom of this screen. UV/VIS Change Wavelength allows users to set switching point for UV/VIS lamps, while 363nm is set as default. Switch to Single Cell allows users to switch accessories between Single Cell and accessories; e.g., Multi-Cell or Sipper. Scan Base Line at Power On allows users to determine whether to execute base-line measurement or not right after turning on the power.

Measure Bandwidth

To perform bandwidth measurement by pressing READ. This measurement detects spectrum on UV lamp and the result is used for calibration (Figure 4.7). If the calibration for this instrument is correct, there is a peak shown around wavelength 656.1nm and the bandwidth is less than 2nm. After calibration, two functions are available for users to choose: Print Data for printing the results, and Prev Screen for going back to the System Setup Menu screen.

12:00:00		500.0nm		0.000A	
Accessory Parameter Setup					
1.UV/VIS change wavelength		:363.0			
2.Switch to Single Cell		:No			
3.Scan base line at POWER ON		:No			
Number from 330.0 to 365.0...					
		Print Data		Prev Screen	

Figure 4.6 Accessory Parameter Setup screen

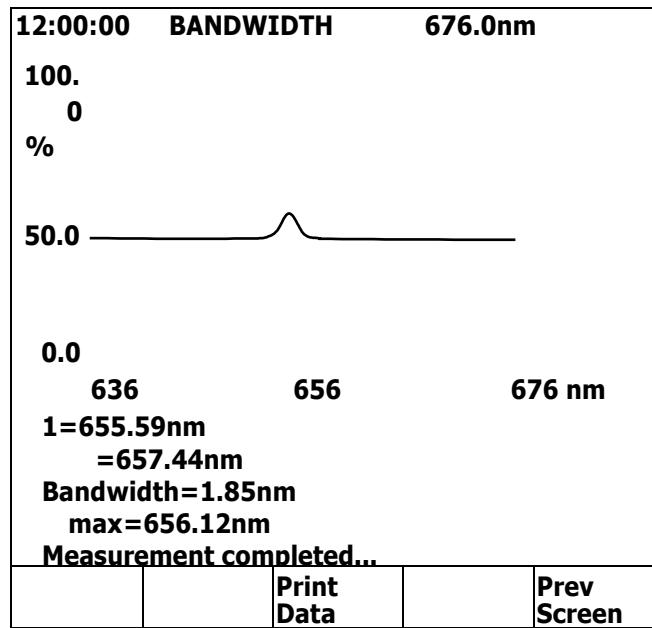

Figure 4.7 Bandwidth measurement screen

Measure Base line

To execute the base-line measurement immediately after the ENTER key is pressed.

Search Zero Position

To perform Zero Position test for hardware.

Chapter 5 Photometric

This is a simple measurement mode with fixed wavelengths. According to the parameter setup, users can repeat a measurement and a table of the measurement results will be shown. The results can be printed with proper settings.

In System Main Menu, selecting item 1 will get into this mode. Instrument and analysis parameters are set up in the PHOTOMETRIC Parameter Setup screen (Figure 5.1). Move the cursor to required parameter by using up/down arrow keys and change values of parameters. Once parameters have been set, press F5 Next Screen to get into the PHOTOMETRIC array-typed screen. When samples are prepared ready, press READ to proceed the measurement. Measuring results will be shown in the screen.

12:00:00 PHOTOMETRIC 500.0nm				
Parameter Setup				
1.Input the Number of		:1		
1 :500.0				
2.Measure mode		:ABS		
Have unit(Yes/No)?		:Yes		
Unit		:		
Factor(default=1)		:1.000		
3.Cycle number		:1		
4.Cycle interval(sec)		:0		
5.Print every cycle		:No		
Number from 1 to 5...				
Load	Save	Print	Sample	Next
Param	Param	Data	Control	Screen

Figure 5.1 Photometric Parameter Setup screen

Five functions are available in the first screen of this mode for users to select: Load Param, Save Param, Print Data, Sample Control, and Next Screen.

§5-1 Photometric Parameter Setup

Input the Number of	For entering the number of wavelength (1 to 5) and the value(s) of wavelength to be used in the Photometric mode.
Measure Mode	Selecting measurement results in ABS as for absorbance, in %T as for transmittance, or in Conc as for concentration.
Cycle Number	For entering the number of cycles (1 to 999) that a sample is required to be measured. One sample being measured through all desired wavelengths is called as one cycle.
Cycle Interval (sec)	For entering the time (0 to 9999) between the end of previous cycle

and the beginning of next cycle.

Print Every Cycle

Selecting Yes or No by pressing left/right arrow keys to print at the end of every cycle.

§5-2 Photometric Function Structure

- Photometric - | Load Param
- | Save Param
- Print Data
- Sample Control
- Next Screen - · Print Data
- Prev Screen

For functions not described below, please refer to General function description section.

§5-3 Basic Photometric Measurement

The following is a description of the basic procedure for carrying out measurement in the SP-8001 Photometric measurement mode. For example, five samples are ready to proceed photometric measurement in 4 wavelengths: 400, 450, 500, and 550.

Step 1. In System Main Menu, select 1; then, press ENTER to get into the Parameter Setup screen.

Step 2. In Parameter Setup screen (Figure 5.2), key in the number of and the corresponding values of . Each entry is followed by an ENTER key. Then go through other items (2 to 5) with proper entries as instructed. If any setting needs correction, use up/down arrow keys to move the cursor

12:00:00 PHOTOMETRIC 500.0nm				
Parameter Setup				
1.Input the Number of :4				
1 :400		2 :450		
3 :500		4 :550		
2.Measure mode :ABS				
Have unit(Yes/No)? :Yes				
Unit :				
Factor(default=1) :1.000				
3.Cycle number :1				
4.Cycle interval(sec) :0				
5.Print every cycle :No				
Number from 1 to 5...				
Load Param	Save Param	Print Data	Sample Control	Next Screen

Figure 5.2 Setting of parameters

to the proper position. When all is done, press F5 Next Screen to next step.

Step 3. Get a sample ready and press READ. The reading of that sample will be displayed on the screen. Repeat this step for other four samples. Readings of measurements will be displayed in the screen (Figure 5.3).

Step 4. Data obtained in every measurement can be printed by pressing F3 Print Data. To get back to Parameter Setup screen, press ESC or F5 Prev Screen.

12:00:00 PHOTOMETRIC 550.0nm					
	400.0	450.0	500.0	550.0	
No	ABS1	ABS2	ABS3	ABS4	
1	0.855	1.223	1.501	1.802	
2	0.855	1.224	1.502	1.803	
3	0.854	1.223	1.502	1.801	
4	0.855	1.224	1.503	1.803	
5	0.854	1.223	1.501	1.802	
Press READ when ready...					
		Print Data		Prev Screen	

Figure 5.3 Photometric readings of samples

A very simple way to perform photometric measurement if users only need to get readings of samples in a specific wavelength.

Step 1. In System Main Menu, press in the keyboard to get into the Lambda screen (Figure 5.4).

Step 2. Get the sample ready for measurement. In the Lambda screen, key in the value for wavelength

12:00:00 LAMBDA 500.0nm				
: 500.0 nm				
Data: 0.000 A				
Press & keyin wavelength...				
View Data	Save Data	Mode A/C/%T	Sample Control	Toggle Digits

Figure 5.4 Lambda screen

and press ENTER. The reading of the measurement will show up in the screen.

Step 3. After the measurement, press F3 Mode A/C/%T can switch reading into different formats: A as for Abs, C as for concentration, and %T as for transmittance. Value of factor will be asked for those choosing Mode in C (Figure 5.5).

Step 4. When the reading is in ABS format, user may press F5 Toggle Digits to show five digits for more precise reading (Figure 5.6). This function can only work under the ABS format.

Step 5. After the measurement, pressing F2 Save Data can save the current reading. The saved data

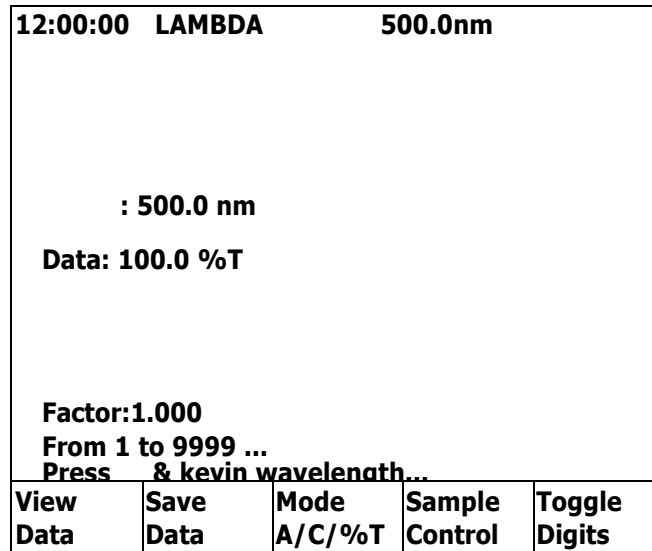

Figure 5.5 Reading in %T format

will be displayed at the bottom of the screen (Figure 5.7). Up to 60 sets of data can be saved.

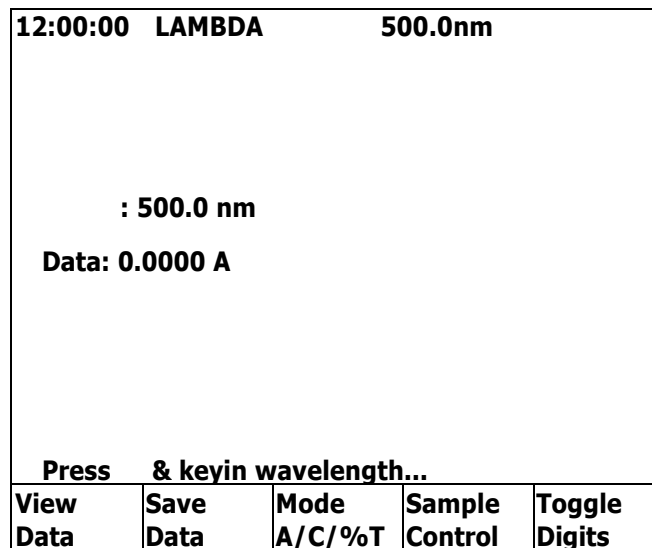

Figure 5.6 Five-digit reading

Step 6. After data saved, pressing F1 View Data can get into the Data File List screen (Figure 5.8). It will show the first 15 sets of data being saved. In this screen, functions F1 Prev Page is for viewing

12:00:00 LAMBDA 500.0nm				
: 500.0 nm				
Data: 0.000 A				
Data01 500.0nm 0.000A				
Press & kevin wavelength...				
View Data	Save Data	Mode A/C/%T	Sample Control	Toggle Digits

Figure 5.7 Saving data of measurement

previous page and F2 Next Page is for viewing next page. Pressing F3 Print Data will print out all sets of data (60 sets the maximum). The saved data will be erased once users exit from this mode.

12:00:00 LAMBDA 600.0nm		
Data File List		

Data01	500.0nm	0.000A
Data02	500.0nm	100.0%T
Data03	400.0nm	1.200A
Data04	500.0nm	72.0%T
Data05	600.0nm	0.000A
Prev Page	Next Page	Print Data
		Prev Screen

Figure 5.8 Data File List screen

Chapter 6 Spectrum

This is the mode in which spectral measurement is performed. Measured spectra can be saved to memory and be subjected to various data manipulation described in details below. The measured spectra can be zoomed by changing the interested range. Interested point of the spectra can be tracked manually and the corresponding data will be shown in the screen. Peaks or valleys of measured spectra can be automatically picked up and corresponding data can be shown in the screen. The number of interested peaks or valleys can be changed in the same spectra. Multiple spectra can be viewed in the same graph for comparison purpose.

In System Main Menu, selecting item 2 will get into this mode. Instrument and analysis parameters are set up in the SPECTRUM Parameter Setup screen (Figure 6.1). Move the cursor to required parameter by using arrow keys and change values of parameters as needed. Once parameters have been set, press F5 Next Screen to get into the SPECTRUM measuring graph screen. When samples are prepared ready, press READ to proceed the measurement. Measuring results will be shown in the screen.

Five functions are available in the first screen of this mode for users to select: Load Param, Save Param,

12:00:00 SPECTRUM 500.0nm				
Parameter Setup				
1.Start wavelength(nm)		:400.0		
2.Stop wavelength(nm)		:800.0		
3.Measure mode		:ABS		
4.Low value(ABS)		:-0.30		
5.High value(ABS)		:3.00		
6.Scan speed(nm/min)		:1000		
7.Overlay screen		:Yes		
Number from 190 to 1098...				
Load Param	Save Param	Print Data	Sample Control	Next Screen

Figure 6.1 Spectrum Parameter Setup screen

Print Data, Sample Control, and View Graph.

§6-1 Spectrum Parameter Setup

Start Wavelength (nm)

For entering the Start Wavelength in Spectrum mode between 190nm and 1098nm.

Stop Wavelength (nm)

For entering the Stop Wavelength in Spectrum mode between 192nm and 1100nm. The Stop Wavelength must be at least 2nm greater than the Start Wavelength.

Measure Mode	Selecting measurement results in ABS as for absorbance or in %T as for transmittance.
Low Value	For entering the lower limit of measurement result between -0.3 and 2.99 for ABS and between 0 and 119.9 for %T, respectively.
High Value	For entering the upper limit of measurement result between -0.29 and 3.00 for ABS and between 0.1 and 120.0 for %T, respectively. The High Value must be at least 0.1 greater than the Low Value regardless the mode.
Scan Speed (nm/min)	For entering the Scan Speed in Spectrum mode between 100 and 5000 (nm/min).
Overlay Screen	Selecting Yes or No to overlay the current measurement with previous measurements. Note that only data for the current measurement can be manipulated.

§6-2 Spectrum Function Structure

Spectrum -		Load Param		Load Data		Prev Page						
		Save Param		Save Data								
		Print Data		Print Data								
		Sample Control		Smooth Data			View Data -	Next Page				
	·		Next Screen -		Access Data -		Print Data					
					Manipulate -			Zoom Data	Save Data	Print Data		
								Show Track -	Print Data	Prev Screen		
					·				·	Peak Valley -	View Data -	Prev Page
										Original	Search Peak	Next Page
					·				·	Clear Graph	Search Valley	Print Data
Prev Screen	Less Point	Prev Screen										
				More Point								

For functions not described below, please refer to General function description section.

Access Data	To load existing data from memory or to save data of current measurement into memory.
Smooth Data	To smooth the data of current measurement in the screen. Note that only the current measurement will go through this function and will be shown after completion of this function.
Zoom Data	To zoom in the selected range of data in the current screen. Key in proper values at blinking cursor followed by ENTER keys and the selected range of data can be zoomed.
Show Track	A vertical dotted line will show up as a tracking cursor. Left/right

arrow keys can be used to move the cursor and the corresponding data will be displayed at the upper right of the screen. In this function, users press Save Data to temporarily save data of the points being tracked. Those data can only be used as pressing F1 View Data or F3 Print Data and will be vanished once jumping out from this function.

View Data	To review data being saved under function Show Track or being found under function Peak Valley.
Prev Page	To review data in the previous page. Only 15 sets of data can be displayed in one screen.
Next Page	To review data in the next page. Only 15 sets of data can be displayed in one screen.
Peak Valley	For users to find peaks or valleys in the current graph.
Search Peak	To search peaks in the current graph. Tiny squares show in the graph to represent the peaks found under this function. The corresponding data can be viewed under View Data function.
Search Valley	To search valleys in the current graph. Tiny squares show in the graph to represent the valleys found under this function. The corresponding data can be viewed under View Data function.
Less Point	To reduce the number of peaks or valleys found in the current graph. The corresponding data can be viewed under View Data function.
More Point	To find more peaks or valleys in the current graph. The corresponding data can be viewed under View Data function.
Original	To redraw the graph from data obtained in the current measurement.

§6-3 Basic Spectrum Measurement

The following is a description of the basic procedure for carrying out measurement in the SP-8001 Spectrum measurement mode. For example, a spectrum of sample is to be measured from 400nm to 800nm and the results should be bounded between 0 and 1.5Abs. Scanning speed is set at 1000nm/min.

Step 1. In System Main Menu, select 2; then, press ENTER to get into the Parameter Setup screen.

Step 2. In Parameter Setup, key in desired values or select proper choice in those 7 items step by step, followed by an ENTER (Figure 6.2). If any setting needs correction, use up/down arrow keys to move the cursor to the proper position. When all is done, press F5 Next Screen to get into the Spectrum screen.

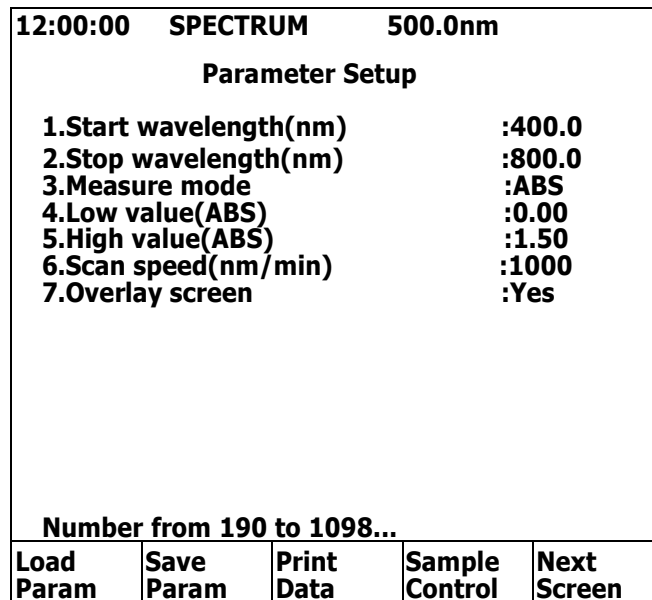

Figure 6.2 Setting of parameters

Step 3. Make the sample ready and press READ. The measurement result will be displayed in the Spectrum screen (Figure 6.3) in real-time mode. The upper right corner of the screen will show the current wavelength and the current reading.

Step 4. When parameter Overlay Screen is set Yes, every measurement result will be displayed on the Spectrum screen. Pressing F3 Clear Graph can clear all graphs in the screen.

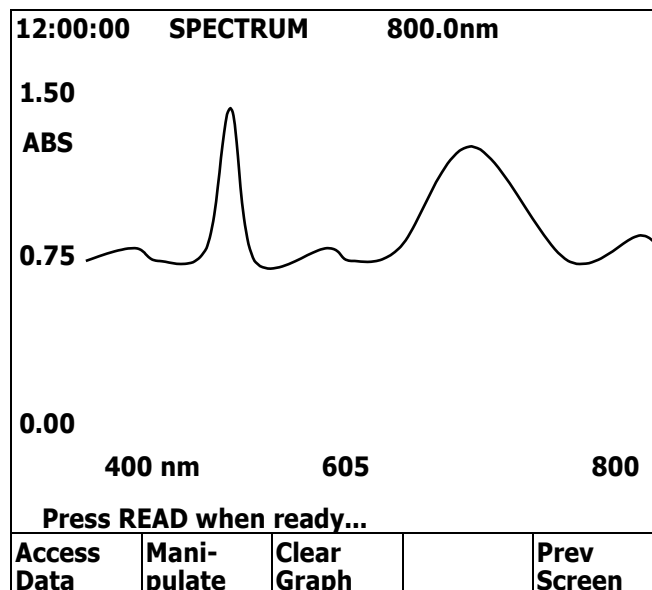

Figure 6.3 Measuring result in Spectrum screen

Step 5. If users want to manipulate data of results, press F2 Manipulate to get into another layer of function keys (Figure 6.4). Then, press F1 Smooth Data and it will smooth the current graph to reduce the effect of noise. To zoom data, go to Step 6; to show track, go to Step 7; and to search peaks and valleys of the graph, go to Step 9.

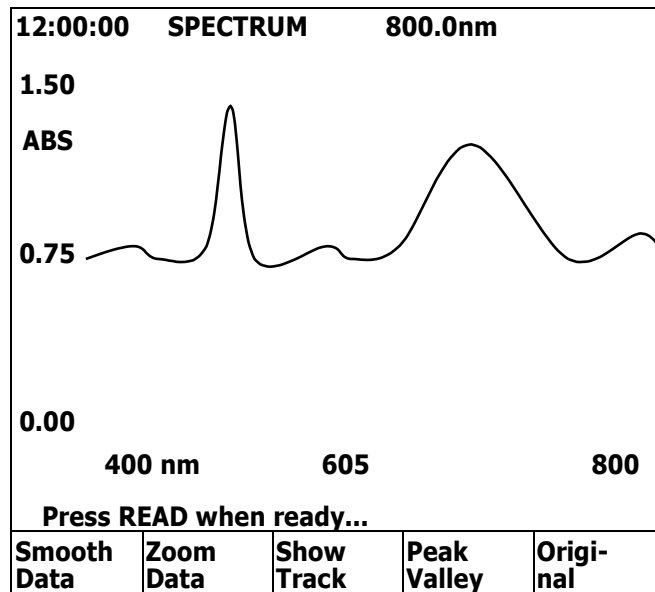

Figure 6.4 Functions for manipulating graph

Step 6. If users want to view part of the graph, function Zoom Data is designed for this purpose. Press F2 Zoom Data, then cursor will sequentially move through 1.50 (High Value), 0.00 (Low Value) of the vertical axis and 400 (Start Wavelength), 800 (Stop Wavelength) of the horizontal axis in the graph. Key in the desired value followed by an ENTER key, cursor will move on to the next input position. After all inputs done, the instrument will display a new graph subject to the newly defined parameters (Figure 6.5).

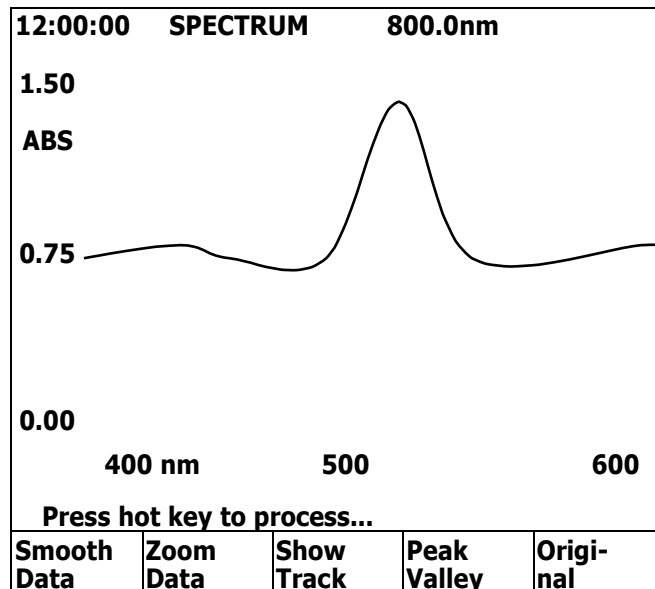

Figure 6.5 Graph with zoomed data

Step 7. If users want to trace readings of measurement result, function Show Track is designed for this purpose. Pressing F3 Show Track will make a dotted vertical line showing up in the graph (Figure 6.6). Use left/right arrow keys to move the dotted line one pixel in the corresponding direction. Use up/down arrow keys to move dotted line ten pixels in right and left directions respectively.

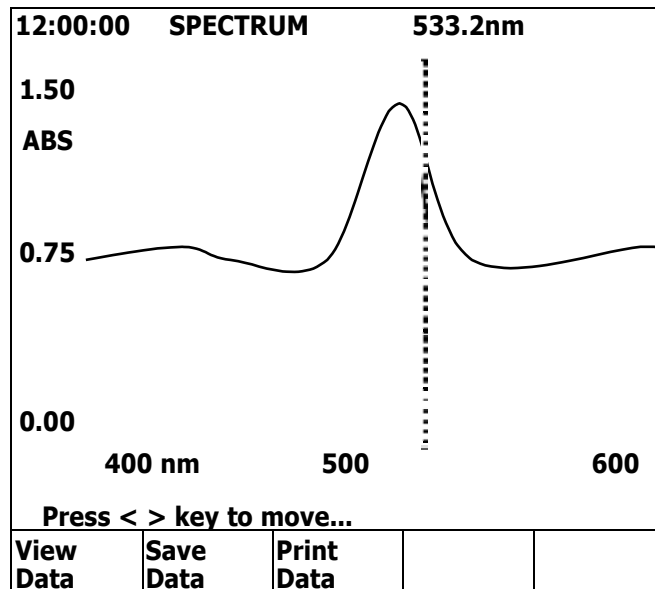

Figure 6.6 Graph under Show Track function

During the tracing process, corresponding values for traced point will be displayed at the up right corner in the screen.

Step 8. Under Show Track mode, data of the traced point can be saved by pressing F2 Save Data. And a number will be assigned automatically to that traced point. The number will be displayed at the lower right corner in the screen (Figure 6.7). Total 60 sets of data can be saved. In this mode, pressing F3 Print Data will print out this screen with the dotted line. Pressing F1 View Data will show the Data File List screen that displays all saved data in the Show Track mode.

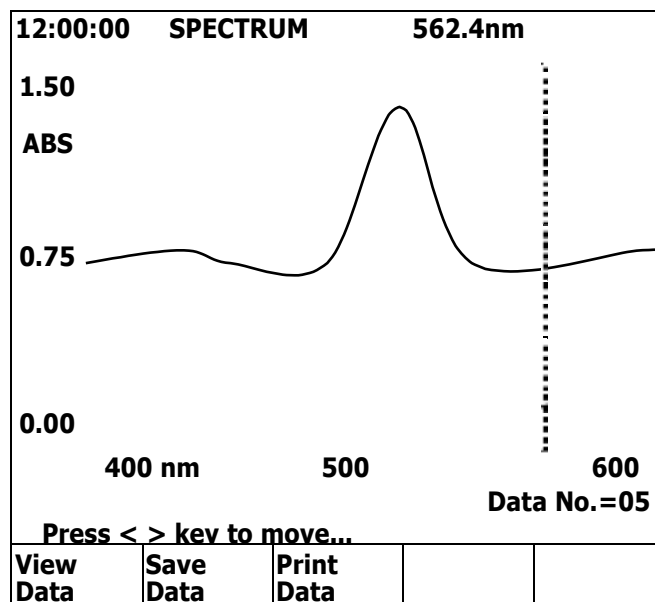

Figure 6.7 Saving data in Show Track mode

Step 9. In the Spectrum screen, pressing function Manipulate and then function Peak Valley will get into the mode that peaks and valleys of the graph can be picked up automatically. In this searching mode, pressing F2 Search Peak will mark all peaks in the graph (Figure 6.8). Functions F4 and F5 will let users to adjust the number of points being picked. Detailed data of those points can be

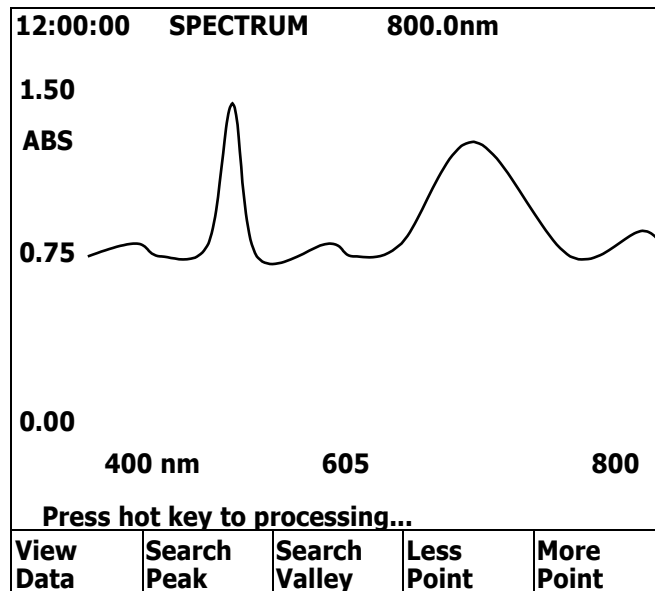

Figure 6.8 Searching peaks of the spectrum

viewed by pressing F1 View Data to see the wavelength and the corresponding reading (Figure 6.9).

12:00:00 SPECTRUM 800.0nm		
Data File List		

Data01	413.2nm	0.344A
Data02	498.8nm	1.415A
Data03	587.1nm	0.352A
Data04	714.3nm	1.065A
Data05	787.5nm	0.534A

Prev Page	Next Page	Print Data		Prev Screen
-----------	-----------	------------	--	-------------

Figure 6.9 Data File List for peaks

Chapter 7 Timescan

This is the mode in which absorbance versus time measurement of a sample is performed for the accurate study of continuous changes in reaction rates. Delay Time can be set before the start of Scan Time. Results can be shown in a graph and also be manipulated in various ways as needed.

In System Main Menu, selecting item 3 will get into this mode. Instrument and analysis parameters are set up in the TIMESCAN Parameter Setup screen (Figure 7.1). Move the cursor to required parameter by using arrow keys and change values of parameters. Once parameters have been set, press function Next Screen to get into the TIMESCAN measuring graph screen. When samples are prepared ready, press READ to proceed the measurement. Measuring results will be shown in the screen.

12:00:00 TIMESCAN 500.0nm				
Parameter Setup				
1.Wavelength(nm)		:500.0		
2.Scan time(sec)		:30		
3.Delay time(sec)		:0		
4.Measure mode		:ABS		
5.Low value(ABS)		:-0.30		
6.High value(ABS)		:3.00		
7.Overlay screen		:Yes		
Number from 190 to 1100...				
Load Param	Save Param	Print Data	Sample Control	Next Screen

Figure 7.1 TimeScan Parameter Setup screen

Five functions are available in the first screen of this mode for users to select: Load Param, Save Param, Print Data, Sample Control, and Next Screen.

§7-1 TimeScan Parameter Setup

Wavelength (nm)	For entering the value of wavelength to be used in the TimeScan mode. The value should range from 190 to 1100.
Scan Time (sec)	For setting the time in second over which the sample will be measured. The value should range from 5 to 3000.
Delay Time (sec)	For setting the time in second between pressing READ and the start of the measurement. The value should range from 0 to 50.
Measure Mode	Selecting measurement results in ABS as for absorbance or in %T as for transmittance.

Low Value	For entering the lower limit of measurement result between -0.3 and 2.99 for ABS and between 0 and 119.9 for %T, respectively.
High Value	For entering the upper limit of measurement result between -0.29 and 3.00 for ABS and between 0.1 and 120.0 for %T, respectively. The High Value must be at least 0.1 greater than the Low Value regardless the mode.
Overlay Screen	Selecting Yes or No to overlay the current measurement with previous measurements. Note that only data for the current measurement can be manipulated.

§7-2 TimeScan Function Structure

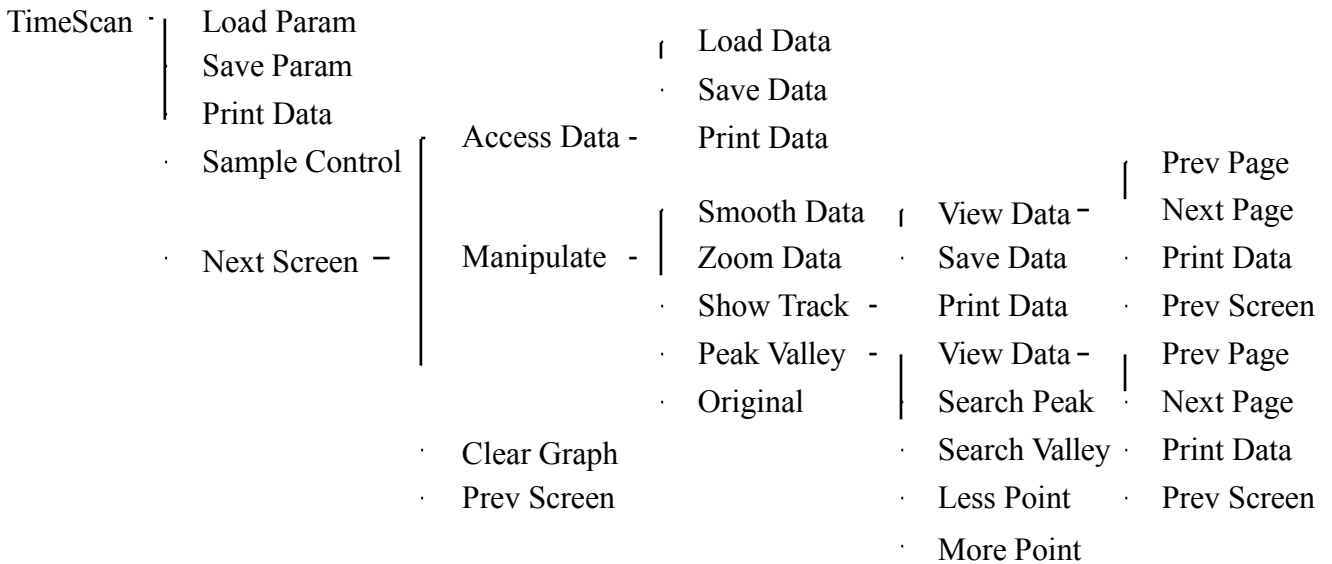

For functions not described below, please refer to General Function Description section.

Access Data	To load existing data from memory or to save data of current measurement into memory.
Smooth Data	To smooth the data of current measurement in the screen. Note that only the current measurement will go through this function and will be shown after completion of this function.
Zoom Data	To zoom in the selected range of data in the current screen. Key in proper values at blinking cursor followed by ENTER keys and the selected range of data can be zoomed.
Show Track	A vertical dotted line will show up as a tracking cursor. Right/left arrow keys can be used to move the cursor and the corresponding data will be displayed at the upper right of the screen. In this function, users press Save Data to temporarily save data of the points

being tracked. Those data can only be used as View Data or Print Data being pressed and will be vanished once jumping out from this function.

View Data	To review data being saved under function Show Track or being found under function Peak Valley.
Prev Page	To review data in the previous page. Only 15 sets of data can be displayed in one screen.
Next Page	To review data in the next page. Only 15 sets of data can be displayed in one screen.
Peak Valley	For users to find peaks or valleys in the current graph.
Original	To redraw the graph from data obtained in the current measurement.

§7-3 Basic TimeScan Measurement

The following is a description of the basic procedure for carrying out measurement in the SP-8001 TimeScan measurement mode. For example, users want to know the measurement change of a sample in a time span of 300 seconds at wavelength 500nm.

Step 1. In System Main Menu, select 3; then, press ENTER to get into the Parameter Setup screen.

Step 2. In Parameter Setup screen (Figure 7.2), key in required values in the corresponding parameters. Each entry is followed by an ENTER key. If any setting needs correction, use up/down arrow keys to move the cursor to the proper position. When all is done, press F5 Next Screen to next step.

Step 3. Make the sample ready and press READ. The measurement result will be displayed in the TimeScan screen (Figure 7.3) in real-time mode.

12:00:00 TIMESCAN 500.0nm				
Parameter Setup				
1.Wavelength(nm)		:500.0		
2.Scan time(sec)		:300		
3.Delay time(sec)		:0		
4.Measure mode		:%T		
5.Low value(ABS)		:99.0		
6.High value(ABS)		:101.0		
7.Overlay screen		:Yes		
Number from 190 to 1100...				
Load Param	Save Param	Print Data	Sample Control	Next Screen

Figure 7.2 Setting of parameters

Step 4. After the measurement, functions can be selected in the same way as in Spectrum mode.

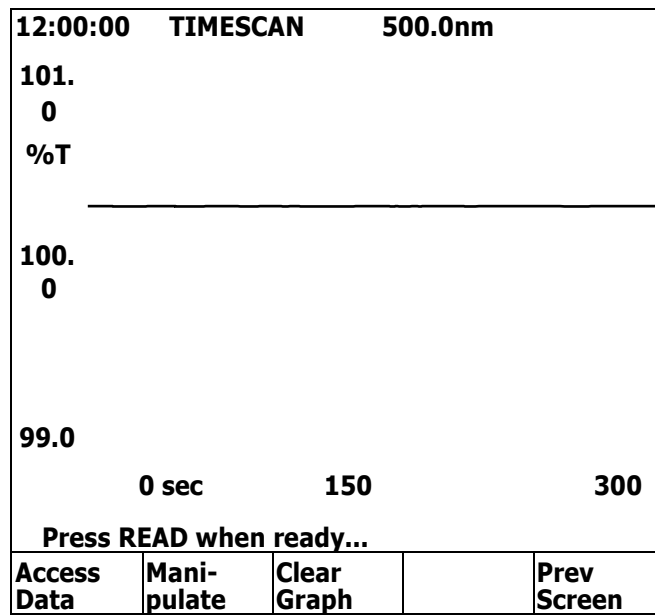

Figure 7.3 Measurement in TimeScan screen

Chapter 8 Kinetic

In this mode, the time-dependent changes in absorbance (ABS) at a fixed wavelength are measured and recorded. A typical application in this mode is the measurement of an enzyme activity. The time changes in absorbance will be displayed on screen and the absorbance can be found at each sampling interval, set according to Lag Time plus with Rate Time. The segment after measurement has started which is not subject to activity computation is set as Lag Time. The amount of change in absorbance is calculated as Rate Time that is evenly divided. The rate of change in absorbance is calculated with the least square method and can be recalculated for different segments by resetting the Lag Time and Rate Time for the same graph.

In System Main Menu, selecting item 4 will get into this mode. Instrument and analysis parameters are set up in the KINETIC Parameter Setup screen (Figure 8.1). Move the cursor to required parameter by using arrow keys and change values of parameters. Once parameters have been set, press function View Graph to get into the KINETIC measuring graph screen. When samples are prepared ready, press READ to proceed the measurement. Measuring results will be shown in the screen.

12:00:00 KINETIC 500.0nm 0.000A				
Parameter Setup				
1.Wavelength(nm)		:500.0		
2.Sampling Number		:5		
3.Lag Time(sec)		:2		
4.Rate Time(sec)		:12		
5.Delay Time(sec)		:0		
6.Have unit(Yes/No)?		:No		
7.Factor(default=1)		:1.0		
8.Low Value(ABS)		:-0.30		
9.High Value(ABS)		:3.00		
10.Measure Temperature		:None		
11.Overlay Screen		:Yes		
12.Print every cycle		:No		
Number from 2 to 99...				
Load Param	Save Param	Print Data	Sample Control	Next Screen

Figure 8.1 Kinetic Parameter Setup screen

Five functions are available in the first screen of this mode for users to select: Load Param, Save Param, Print Data, Sample Control, and Next Screen.

§8-1 Kinetic Parameter Setup

Wavelength (nm)	For entering the value of wavelength to be used in the Kinetic mode. The value should range from 190 to 1100.
Sampling number	For entering the sampling number of a measurement in the Kinetic mode. This number of data is used for the activity calculations. The value should range from 2 to 20.
Lag Time (sec)	For setting the time in second from the start of measurement during which data will not be acquired for activity calculations. The value should range from 2 to 9999.
Rate Time (sec)	For setting the time in second after the Lag Time during which data will be acquired for activity calculations. The value should range from 3 to 9999.
Delay Time (sec)	For setting the time in second between pressing READ and the start of the measurement. The value should range from 0 to 50.
Have Unit (Yes/No)?	Selecting the unit option for measurement result. When Yes is selected, pick the right unit out of the thirteen build-in units in table.
Factor (default=1)	For entering the value of Factor. This factor is used for converting the absorbance rate of change into the activity value. Activity Value = Factor X Abs Rate of Change (ABS/min) The value should range from 0 to 9999.
Low Value (ABS)	For entering the lower limit of measurement result between -0.3 and 2.99 for ABS.
High Value (ABS)	For entering the upper limit of measurement result between -0.29 and 3.00 for ABS. The High Value must be at least 0.1 greater than the Low Value.
Measure Temperature	Selecting temperature control over the measurement. Four selections are available: None, 25, 30, and 37 in Celsius. It can be functional only when a temperature controlled accessory being installed.
Overlay Screen	Selecting Yes or No to overlay the current measurement with previous measurements. Note that only data for the current measurement can be manipulated.
Print Every Cycle	Selecting Yes or No to print at the end of every cycle.

§8-2 Kinetic Function Structure

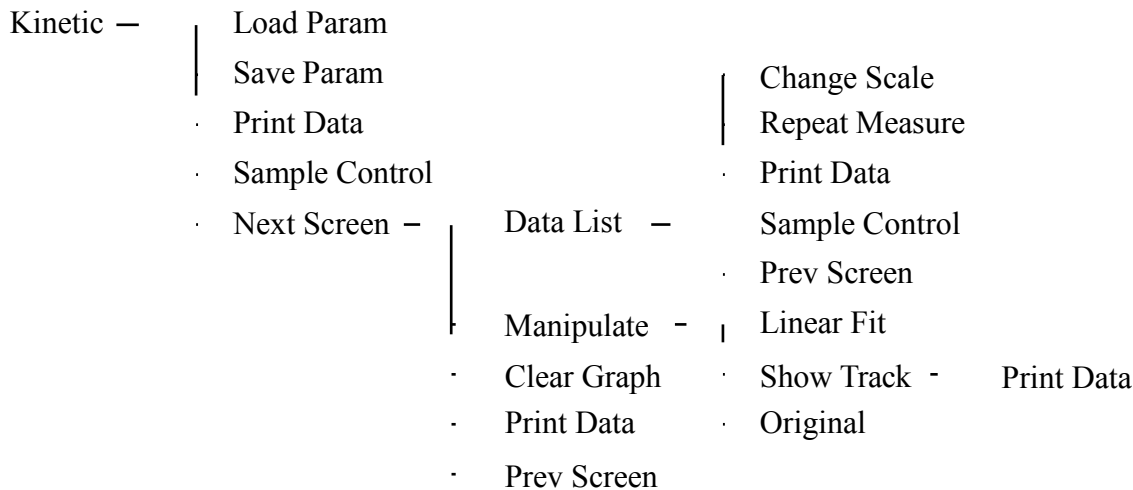

Data List	Switch to the KINETIC Data File List screen for users to review data obtained in previous measurements after setup of parameters.
Change Scale	For users to perform measurements with different values of Lag Time and Rate Time. Pressing this function key will switch input fields for users to key in values. Measurement results can still be shown in the same KINETIC Data File List screen.
Repeat Measure	To repeat the measurement once under the current parameter setup.
Linear Fit	To perform linear fitting for the current measurement.
Show Track	A vertical dotted line will show up as a tracking cursor. Left/right arrow keys can be used to move the cursor and the corresponding data will be displayed at the upper right of the screen. In this function, users press F2 Save Data to save data of the points being tracked. Those data can only be used as F1 View Data or F3 Print Data being pressed and will be vanished once jumping out from this function.
View Data	To review data being saved under function Show Track or being found under function Peak Valley.
Prev Page	To review data in the previous page. Only 15 sets of data can be displayed in one screen.
Next Page	To review data in the next page. Only 15 sets of data can be displayed in one screen.
Original	To redraw the graph from data obtained in the current measurement.

§8-3 Basic Kinetic Measurement

The following is a description of the basic procedure for carrying out measurement in the SP-8001 Kinetic measurement mode. For example, users want to know the reaction of a reagent in a time span of 60 seconds after 60-second lag time by sampling 5 times at wavelength 405nm, assuming that factor is 3253 and unit is set as U/L.

Step 1. In System Main Menu, select 4; then, press ENTER to get into the Parameter Setup screen.

Step 2. In Parameter Setup screen (Figure 8.2), key in required values in the corresponding parameters.

Each entry is followed by an ENTER. If any setting needs correction, use up/down arrow keys to move the cursor to the proper position. In item 6, select Yes followed by an ENTER key and in the unit list, choose 3 (U/L) followed by an ENTER key. When all is done, press F5 Next Screen to next step.

Step 3. Make the sample ready and press READ. The measurement result will be displayed in the

12:00:00 KINETIC 500.0nm 0.000A				
Parameter Setup				
1.Sampling Number		:5		
2.Wavelength(nm)		:405.0		
3.Lag Time(sec)		:60		
4.Rate Time(sec)		:60		
5.Delay Time(sec)		:0		
6.Have unit(Yes/No)?		:Yes		
7.Factor(default=1)		:3253		
8.Low Value(ABS)		:-0.30		
9.High Value(ABS)		:1.00		
10.Measure Temperature		:None		
11.Overlay Screen		:Yes		
12.Print every cycle		:No		
Number from 2 to 99...				
Load Param	Save Param	Print Data	Sample Control	Next Screen

Figure 8.2 Setting of parameters

Kinetic screen (Figure 8.3) in real-time mode. The measuring curve shows the measurements taken by the instrument. After completion of the measurement, the instrument will take the pre-set number of sampling measurements for calculation to perform linear fitting. The small blocks shown on the curve represent sample measurements during the rate time. Those blocks are used for linear fitting and the equation of regression is shown at the bottom of this screen. T shows the rate time. ABS T shows the absorbance rate of change. C/ T shows the concentration rate of change after conversion by using the factor. In this screen users can to view the data of sampling point by pressing F1 Data List. Pressing F2 Manipulate will go to next step.

Step 4. In this screen, press F2 Linear Fit to get the regression line and it will show on the screen (Figure 8.4). Here, only the regression line and the sampling blocks will show up. Users can also switch back to the original measuring curve by pressing F5 Original.

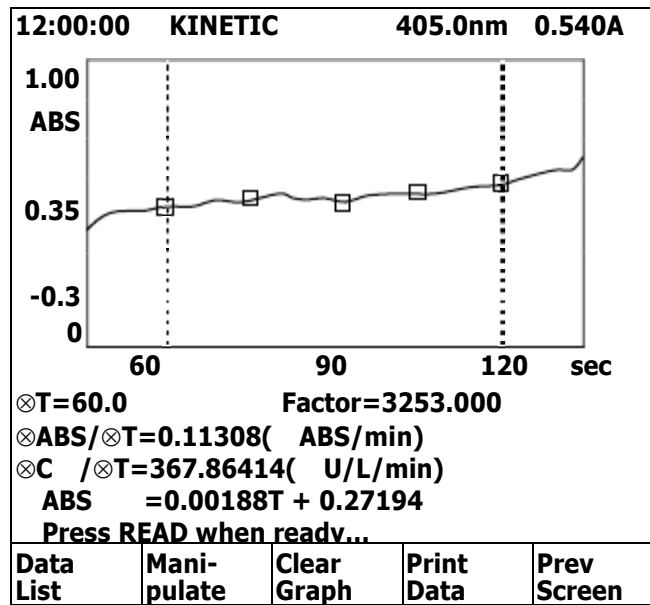

Figure 8.3 Kinetic measuring screen

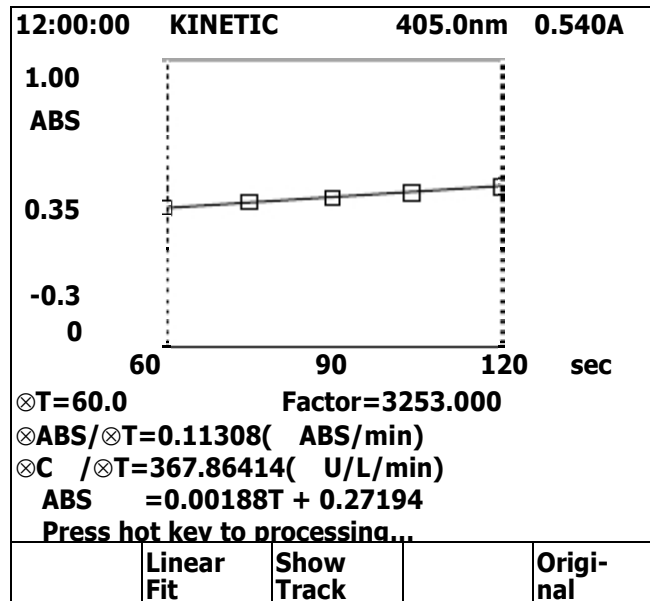

Figure 8.4 Kinetic Manipulate screen

Step 5. In the Kinetic Manipulate screen, users can press F3 Show Track to view data of the measuring curve or the regression line by moving the dotted tracing line.

Chapter 9 Quantitative

This is the mode in which the concentration of an unknown sample under a specific wavelength can be determined by creating a calibration curve from standard samples. Four methods for curve fitting can be selected: straight line with or without passing through origin and 2nd order polynomial with or without passing through origin.

In System Main Menu, selecting item 5 will get into this mode. Instrument and analysis parameters are set up in the QUANTITATIVE Parameter Setup screen (Figure 9.1). Move the cursor to required parameter by using arrow keys and change setting of parameters. Once parameters have been set, press F5 Next Screen to get into the QUANTITATIVE Standard Table screen. When standard samples are prepared ready, press READ to proceed the measurement. Once the standard table has been built up, press function Manipulate to move on. Users then can view the corresponding equation or measure new samples as needed. Measuring results will be shown in the Measure Sample screen.

12:00:00 QUANTITATIVE 500.0nm 0.000A				
Parameter Setup				
1.Wavelength(nm)		:500.0		
2.Standard number(Conc.)		:3		
S 1:0.0		S 2 :0.0		
S 3:0.0				
3.Have Unit(Yes/No)		:No		
4.Method		:1'ord.(Origin)		
5.Keyin ABS		:No		
6.Print every cycle		:No		
Number from 190 to 1100...				
Load Param	Save Param	Print Data	Sample Control	Next Screen

Figure 9.1 Quantitative Parameter Setup screen

Five functions are available in the first screen of this mode for users to select: Load Param, Save Param, Print Data, Sample Control, and Next Screen.

§9-1 Quantitative Parameter Setup

Wavelength (nm)

For entering the value of wavelength to be used in the Quantitative mode. The value should range from 190 to 1100.

Standard Number (Conc.)

For entering the number of standard samples used in the process. The value should range from 1 to 10. Concentration for each standard sample can also be entered in the corresponding fields.

Have Unit (Yes/No)	Selecting the unit option for measurement results. When Yes is selected, pick the right unit out of the thirteen build-in units in table.
Method	Four methods of data fitting are available: 1 ^{ord} .(Origin) for straight line through origin, 1 ^{ord} .(No Org) for straight line not passing through origin, 2 ^{ord} .(Origin) for 2 nd ordered polynomial through origin, and 2 ^{ord} .(No Org) for 2 nd ordered polynomial without passing through origin.
Keyin ABS	Selecting Yes for users to manually key in values of ABS. Selecting No for instrument to read ABS values of standard samples automatically. When first time get into the QUANTITATIVE Standard Table screen, press READ to initiate this procedure.
Print Every Cycle	Selecting Yes or No to print at the end of every measurement.

§9-2 Quantitative Function Structure

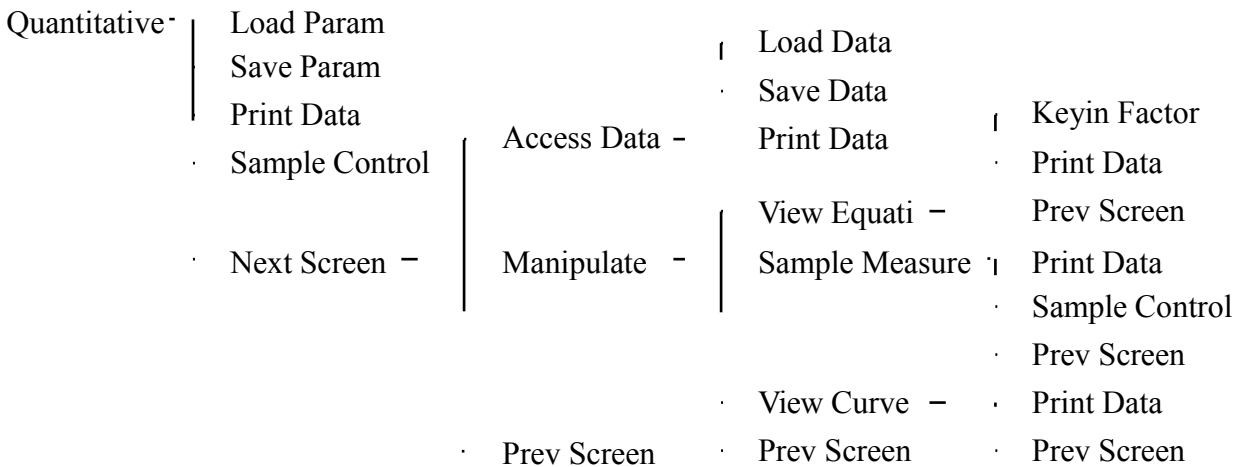

For functions not described below, please refer to General function description section.

Access Data	To load existing data from memory or to save data of current status into memory. Here data refers to those factors of fitted equation with parameter setup in the Quantitative mode. Use ESC key to get back to the function level.
View Equati	To view the fitted equation and associated factors under determined fitting method.
View Curve	To view the fitted equation in graph representation with tiny squares representing data for standard samples.
Keyin Factor	For entering factor values for the fitted equation.
Sample Measure	To get into the QUANTITATIVE Measure Sample screen in order to read samples whenever ready.

§9-3 Basic Quantitative Measurement

The following is a description of the basic procedure for carrying out measurement in the SP-8001 Quantitative measurement mode. In this mode, users use standard samples to determine unknown samples. For example, there are three standard samples with known concentration and absorbance. If the absorbance values are unknown, users can also use the SP-8001 to find out the corresponding absorbance values. Using those data, the relationship between concentration and absorbance can be build up through curve fitting technique. Once the equation being constructed, users can use it to determine concentrations of unknown samples by reading the absorbance from the instrument.

Step 1. In System Main Menu, select 5; then, press ENTER to get into the Parameter Setup screen.

Step 2. In Parameter Setup screen (Figure 9.2), key in required values in the corresponding parameters. Each entry is followed by an ENTER. If any setting needs correction, use Up/Down arrow keys to move the cursor to the proper position. Here, set wavelength at 500 nm. In item 2, input 3 followed by an ENTER key. Then, in the corresponding fields key in concentration values followed by ENTER keys. Select U/L as the unit in item 3. Select 1'ord.(Origin) in item 4 Method. In item 5, set Yes for later keying in absorbance value manually. After all parameters set up, press F5 Next Screen to next step.

Step 3. In the Quantitative Standard Table screen (Figure 9.3), press READ to start to key in absorbance value for corresponding concentration. After finishing the key-in operation, press ESC to exit. Now, press F2 Manipulate to go to next step. After F2 Manipulate being pressed, the SP-8001 will proceed

12:00:00 QUANTITATIVE 500.0nm 0.000A				
Parameter Setup				
1.Wavelength(nm)		:500.0		
2.Standard number(Conc.)		:3		
S 1:1.0		S 2 :2.0		
S 3:3.0				
3.Have Unit(Yes/No)		:Yes		
4.Method		:1'ord.(Origin)		
5.Keyin ABS		:Yes		
6.Print every cycle		:No		
Number from 190 to 1100...				
Load Param	Save Param	Print Data	Sample Control	Next Screen

Figure 9.2 Setting of parameters

calculation for the input data and an equation describing the relation of input data will be build up.

Step 4. Here, different function keys will show in the bottom of this screen (figure 9.4). Press F2

12:00:00 QUANTITATIVE 500.0nm Standard Table				

Sample No.	Conc.(G/L)	ABS		
1	1.0000	0.1		
2	2.0000	0.2		
3	3.0000			
Number from -0.3 to 3.0...				
Access Data	Mani-Repulate			Prev Screen

Figure 9.3 Standard Table screen

Sample Measure to start measurement for unknown samples and it is described in step 5. Pressing F1 View Equati will allow users to view details of the fitted curve and it is described in step 6.

Step 5. In the Quantitative Measure Sample screen (Figure 9.5), get the unknown sample ready and press READ, then the SP-8001 will measure the absorbance of the sample and calculate the

12:00:00 QUANTITATIVE 500.0nm Standard Table				

Sample No.	Conc.(G/L)	ABS		
1	1.0000	0.1		
2	2.0000	0.2		
3	3.0000	0.3		
Press hot key to process...				
View Equati	Sample Measure		View Curve	Prev Screen

Figure 9.4 More functions in Standard Table

corresponding concentration by using the equation obtained before. Results will be shown in the screen and can also be printed by pressing F3 Print Data.

Step 6. In the Quantitative Linear Fitting screen (Figure 9.6), details of the fitted curve will be shown. The equation describes the relation between concentration and absorbance value. K1 and K0 are the coefficients in the equation and depend on the selected method of curve fitting. r^2 shows the correlation coefficient for the fitted equation.

12:00:00 QUANTITATIVE 500.0nm				
Measure Sample				

Sample No.	ABS	Conc.(G/L)		
1	0.521	5.2100		
2	1.137	11.370		
3	2.325	23.250		
Press READ when ready...				
		Print Data	Sample Control	Prev Screen

Figure 9.5 Quantitative Measure Sample screen

12:00:00 QUANTITATIVE 500.0nm				
Linear Fitting				

Conc. = K1*ABS + K0				
K1 = 10.00000				
K0 = 0.00000				
r² = 1.00000				
Keyin Factor		Print Data		Prev Screen

Figure 9.6 quantitative Linear Fitting screen

Chapter 10 Accessories

Metertech. Inc. designed several optional accessories to meet users' specific purposes while the Single cell holder is a standard accessory. When an optional accessory is to be used, users should turn off the instrument first and then do the hardware installation as well as the cable connection. The SP-8001 will automatically detect attached accessory. When the instrument is turned on, the detected accessories will be shown during initialization.

After initialization, pressing function Sample Control will get into screens to set up the parameters of accessories. Whenever function Sample Control shows up in various screen, it can be pressed to run the

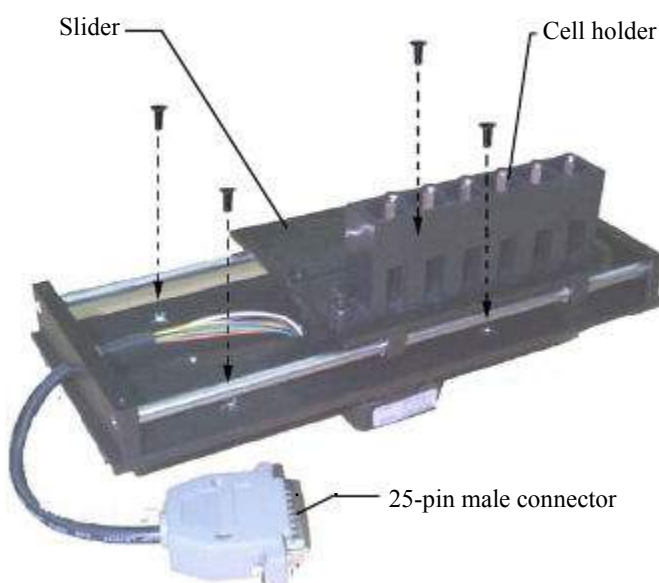

Figure 10.1 Multi-Cell Holder

accessory accordingly. A function named Prev Screen will close up the operation of accessories and back to the previous screen. The optional accessory can be disabled in the System Setup by selecting item 5 Setup Hardware; however, it has to be detected during the initialization process. Hot-plug is not recommended and it may cause damage

§10-1 Multi-Cell Holder

The Multi-Cell Holder is an optional accessory that enables up to 6 cells to be presented for measurement sequentially. Put the Multi-Cell Holder into the sample compartment and fix it with 4 screws as shown in Figure 10.1. Plug the 25-pin male connector into the corresponding female connector in the sample compartment. Turn on the instrument and it will be automatically detected.

When the Multi-Cell Holder is installed, pressing Read will perform measurements of all cells being set according to Drive Cell Number. Also, at the right bottom corner of every screen, a note shows the current

Cell number that is in the measurement position.

A Multi-Cell Parameter Setup screen (Figure 10.2) will show up when function Sample Control being pressed. Detailed settings and respective functions will be described below.

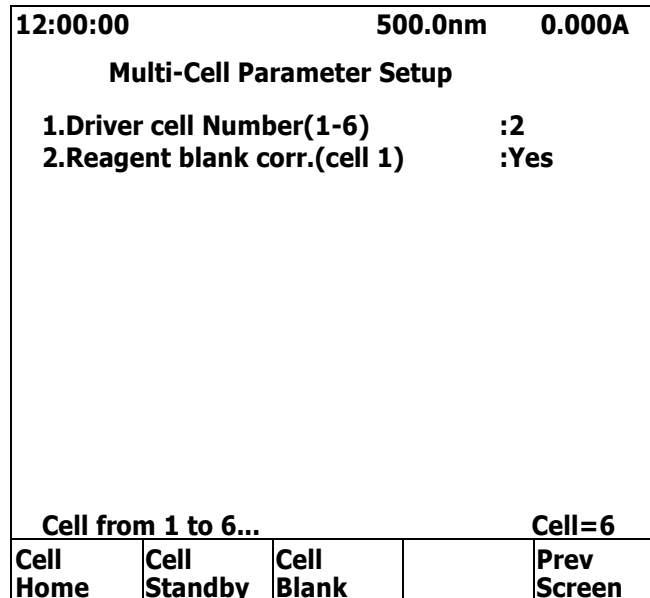

Figure 10.2 Multi-Cell Parameter Setup screen

Driver Cell Number (1-6) For entering the number of cells to be measured. The value should range from 1 to 6.

Reagent Blank Corr. (Cell 1) Selecting Yes to confirm that Cell 1 is used as Blank and No for using base-line as blank.

Three functions are available in this screen: Cell Home, Cell Standby, and Cell Blank.

Cell Home This will make the Multi-Cell Holder in such a position that Cell 1 is ready for the measurement.

Cell Standby This will make the Multi-Cell Holder in such a position that it is convenient for users to exchange cells.

Cell Blank (not available for the time being)

§10-2 Sipper

The Sipper (Figure 10.3) is an optional accessory that enables samples to be drawn into a flow cell for automatic measurement. After the measurement is complete the sample may be sent to a waste bottle or returned to its original vessel.

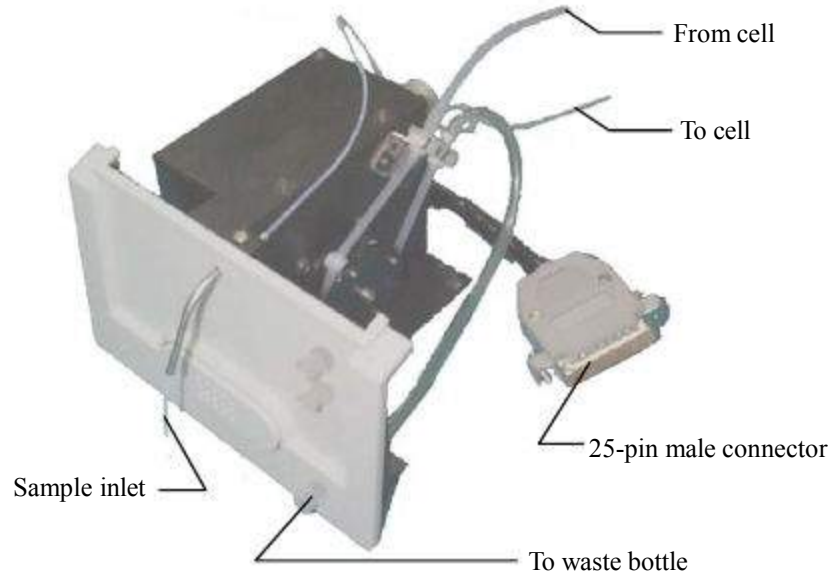

Figure 10.3 Sipper

A Sipper Parameter Setup screen (Figure 10.4) will show up when function Sample Control being pressed. Detailed settings and respective functions will be described below:

12:00:00		500.0nm		0.000A	
Sipper Parameter Setup					
1.Pump speed		:Medium			
2.Pre air purge time(sec)		:2.5			
3.Pre sipper time(sec)		:2.5			
4.Air purge time(sec)		:3.5			
5.Sipper time(sec)		:3			
6.Dwell time(sec)		:1			
Press < > key to select...					
Wash Cell	Sipper Test				Prev Screen

Figure 10.4 Sipper Parameter Setup screen

Pump Speed

Three speeds: Slow, Medium, and Fast can be chosen by using arrow keys to set up the speed of peristaltic pump. This setting only

	applies on the sipping operation for Sipper Time.
Pre Air Purge Time (sec)	For entering the value of time during which Sipper will do the air purge operation for the previous sample. The value should range from 0 to 99.9.
Pre Sipper Time (sec)	For entering the value of time during which Sipper will draw the residual of previous sample passing through the flow cell. The value should range from 0 to 99.9.
Air Purge Time (sec)	For entering the value of time during which Sipper will do the air purge operation as required. This usually applies to those samples that need segmentation by air. The value should range from 0 to 99.9.
Sipper Time (sec)	For entering the value of time for the sipping operation. Samples will be drawn into the flow cell for measurement essentially in this operation of the Sipper. The value should range from 0 to 99.9.
Dwell Time (sec)	For entering the value of time after the sipping operation. This will allow samples getting into a stable condition for measurement. The value should range from 0 to 99.9.

Two functions are available in this screen: Wash Cell and Sipper Test.

Wash Cell	To drive peristaltic pump running for about 15 seconds to wash flow cell whenever needed.
Sipper Test	To execute one cycle of all operations sequentially according to the settings.

Chapter 11 Maintenance

The information given in this section deals only with those parts of maintenance or service which can be safely carried out by users. Work other than those detailed later should be carried out by a trained service engineer.

Poor instrument performance or failure can usually be attributed to simple failure of the tungsten lamp. Therefore, as detailed below, replace the old one with a spare lamp provided before seeking further assistance.

§11-1 Routine Maintenance

Very little maintenance is required to keep the instrument in good working condition. The interior should be kept as dust free as possible and the sample compartment cleaned regularly; wipe off spilt chemicals immediately.

CAUTION: Do not allow moisture to leak into the instrument.

The exterior of the instrument can be cleaned periodically as follows:

- ◆ SWITCH OFF first the instrument and disconnect from the mains supply.
- ◆ Using a lint free cloth dampened with a weak solution of detergent and water, wipe the exterior surface of the instrument as necessary.
- ◆ Wipe over with a soft cloth dampened with clean water.
- ◆ Dry the surface with another soft cloth.

§11-2 Replacement of Lamps

This instrument is designed for easy access in lamp replacement. Minimum adjustment is required for the replacement. The tungsten halogen lamp is seated in a specially designed holder that is located in the right half part in the lamp compartment (Figure 11.1). However the deuterium lamp that comes up with a ring-typed aluminum seat is located in the left half part respectively.

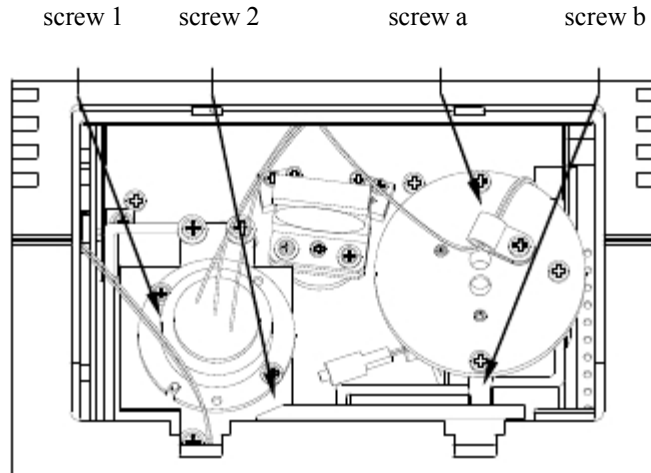

Figure 11.1 Lamp compartment

CAUTION: Switch off and disconnect the instrument from the mains supply and allow the lamp to cool down at least 15 minutes before proceeding.

WARNING: Do not touch lamps with bare hands. Use glove or cloth to prevent staining of the bulb.

WARNING: Pay extreme attention not to touch parts other than those as instructed.

Replacement of tungsten halogen lamp:

- ◆ Remove the cover of lamp compartment.
- ◆ Unscrew the retaining screws (screws a and b in Figure 11.1) of the holder of tungsten halogen lamp. And pull the holder straightly upward.
- ◆ Pull out the damaged lamp from the socket to remove.
- ◆ Use lens paper to hold the new lamp for replacement.
- ◆ Put the whole set back to the original position and screw it tightly
- ◆ Remount the cover of lamp compartment.

Replacement of deuterium lamp:

- ◆ Remove the cover of lamp compartment.
- ◆ Find the rapid connector with red, black, and blue wires and disconnect it.
- ◆ Unscrew the retaining screws (screws 1 and 2 in Figure 11.1) on the white aluminum seat for the

deuterium lamp. Pull the deuterium lamp straightly upward to remove.

- ◆ Put a new deuterium lamp back to the holder and screw it tightly.
- ◆ Reconnect the rapid connector of the deuterium lamp.
- ◆ Remount the cover of lamp compartment.

WARNING: For replacing deuterium lamp or halogen lamp, be sure to contact your local agent, and use vendor's designated light sources.

Light source specifications:

Halogen lamp: 12V, 20W, and lifetime 2000 hrs.

Deuterium lamp: ignition voltage 500V, operating voltage 75-95V, operating current 300mA,
and lifetime 500 hrs.

Appendix A Thermal controller operation

§A-1. Installation of thermal controller on SP8001 machine

- Power off SP8001 machine.
- The thermal controller can be applied to SP8001 in two approaches. It can be an independent unit for rectangular cuvette, or accompanied with sipper for flow through cell.
- For a standard alone thermal controller, a 24 pin to 9 pin cable adapter is required. For operating with sipper, please refer to the operation instruction of sipper.
- Power off SP8001 machine.
- Plug the cable adapter into receptacle at the bottom right wall of SP8001 cell compartment. Remove single cell holder by loosening three M3 screws, locate the cell holder of thermal controller at the same position as single cell holder did. Then tighten it with three M3 screws.
- Connect the 9-pin connector of thermal controller with that of cable adaptor.(if sipper is required, connect 9-pin connector of thermal controller to that of sipper).

§A-2. Operation of thermal controller

- Power on SP8001 machine. For a proper thermal controller installation, a message "Detect Accessory.....Single cell+TC(or Sipper+TC)" under the company logo window of LCD display will be shown. If it displays "Detect Accessory....Single Cell", please power off machine and check thermal controller installation until "TC" message is appeared.
- The default temperature setting is 25°C when the machine is started. If you can not get the correct reading at the bottom-right corner of LCD after 5 minutes from the machine was powered, please turn off machine and inspect the cause of problem.
- Select #6 under System Main Menu of LCD display, and go to the System setup menu. Then pick #5 and go to Accessory parameter setup. Using up/down arrow key to select #4 (setup temperature), here you can choose one temp setting from 37°C, 30°C, 25°C and none(no heating or cooling action) by left and right arrow key. Finally press ENTER key, the temp controller starts to climb up or fall down to your last temp setting. **The settling time from one temp to another is less than 5 minutes, and temp will be stabilized within +/- 0.1°C.**
- Return to system main menu, pick #4 (kinetic mode). Pick #10(measure temp) of the parameter setup, you can also select the temp setting for your experiment.

§A-3. Important notes

- The thermal controller is designed to adapt for two types of flow cell; aperture height with 8.5 mm and 15 mm. The default height is 8.5 mm. If 15 mm height is needed, please remove an aluminum block right down the bottom surface of cell holder with a cross type screw driver.
- If you are using flow cell for experiment, and want get the best light transmission through cell aperture. Please fill pure water into cell and make sure no air bubble inside the aperture. At the Lambda mode of SP8001, key in 500nm, remove cell from cell holder, and AUTOZERO to get 100%T. Put in flow cell with water, loose three screws of thermal controller, and move it forward/backward with respect to front panel until getting reading greater than 50 %T.

Appendix B Sipper operation

§B-1. Installation of sipper on SP8001 machine

- Power off SP8001 machine.
- Remove the front panel of cell compartment of SP8001 by loosening two M3 screws behind it.
- A sipper assembly as shown on fig. 1 includes one pumping drive, one pinch valve(one sample input, and another air input) two connectors(small one for connecting to electronically thermal controlled cell assembly, large one for connecting to SP8001 machine), two flexible tubes, and front panel. The latter one contains sample solution inlet and outlet; thermal controlled water circulation inlet and outlet, and one button.
- Locate the sipper assembly above the cell compartment, plug its large connector into receptacle on the bottom-right wall of cell compartment, set connector cable under sipper assembly.
- Move down the sipper until touching bottom surface, then tighten the sipper on the bottom surface with one M3 screw located at opposite side of sipper's front panel, and one M4 screw beside the pumping wheel.
- Connect two flexible tubes of sipper to those of flow through cell(make sure the length of cell's both tubes are cut properly with length 55 mm).

§B-2. Operation of sipper

- Power on SP8001 machine. For a proper sipper installation, a message "Detect Accessory.....Sipper" under the company logo window of LCD display will be shown. If it displays "Detect Accessory....Single Cell", please power off machine and check sipper installation until "Sipper" message is appeared.
- Press F4 (Sample Control) under System Main Menu of LCD display, and you are going to the sipper parameter setup mode. For a first time using sipper, there is a set of default parameters shown on the LCD, these numbers are suitable for a 10 mm-long flow through cell with aperture diameter 2mm and aperture height 8.5 mm. It gives minimum sipped sample volume around 700 ul with reasonable carryover(depends on the sample viscosity).
- Key F1(wash cell) is for continuously cleaning the cell and tube for 20 seconds. F2(sipper test) is to test the sipper operation with latest parameters setting. F3 for printing out the whole parameter setup. F4 for retrieving default parameter saved in ROM. F5& Esc for going back to last screen. The keyed in parameters will be saved in memory.

- There are six parameters to be set for the sipper to be properly operated. #1 is pump speed selection for sampling solution at low , medium or high speed. #2 and #4 are for air purge times setting, the pump is always preset at high speed. If you do not need air purge between two samplings, just key in zero value(it is suggested to have air purge on during operation to remove the possible accumulated air bubble inside the cell). #3 and #5 is for sample sipping time setting. These two numbers added together gives the total sampling time for a complete sipping operation. # 6 is the delay time to read the sample after the sipping action is stopped.
- In normal operation of the sipper, a button on the sipper front panel has the same function as key "READ". When in the sipper parameter setup mode, key "READ" , "AUTOZERO", and front panel button are not active. They function after leaving this mode.
- Sometimes you do not want do measurement with sipper operated, you can pick #6 (system setup) under system main menu. Then pick #5(setup hardware), then pick #2(switch to single cell). The machine will operate like only one cell installed without actually removing sipper unit. You can also switch it back to sipper mode by selecting "NO".

§B-3. Important notes

- At the first time running sipper, checking the centering of flexible tube sitting on white roller of pumping wheel is very important. Please enter F1 under sipper setup mode to start the pump. If the tube gradually moves towards one side of white roller while wheel is rotating, turn the stop (fig.1) 45/90 degrees cw/cww until the tube returning to center position.
- The peristaltic tube at abnormal condition may not be tightened enough across pumping wheel, such that the sipping force is too small to displace proper amount of solution into the cell. Please check the tube fitness into the stop, or cut the tube shorter(1mm off at one time) to generate more elastic force.
- If flow through cell is used for measurement, cell alignment for max light to pass through aperture is required. Fill the flow cell with water either by sipping or other method, then go to Lambda mode and set wavelength 500 nm, remove flow cell from cell holder, enter "AUTOZERO" and obtain 100%T. Put cell back to cell holder and cover the cell compartment, a good reading would be larger than 50%T(for aperture diameter 2 mm). If reading is smaller than 40 %T, please loose three M3 screws around the cell holder, and move it forward/backward with respect to front panel(there is only 2 mm max moveable displacement) until finding the max reading. Finally tighten these screws.

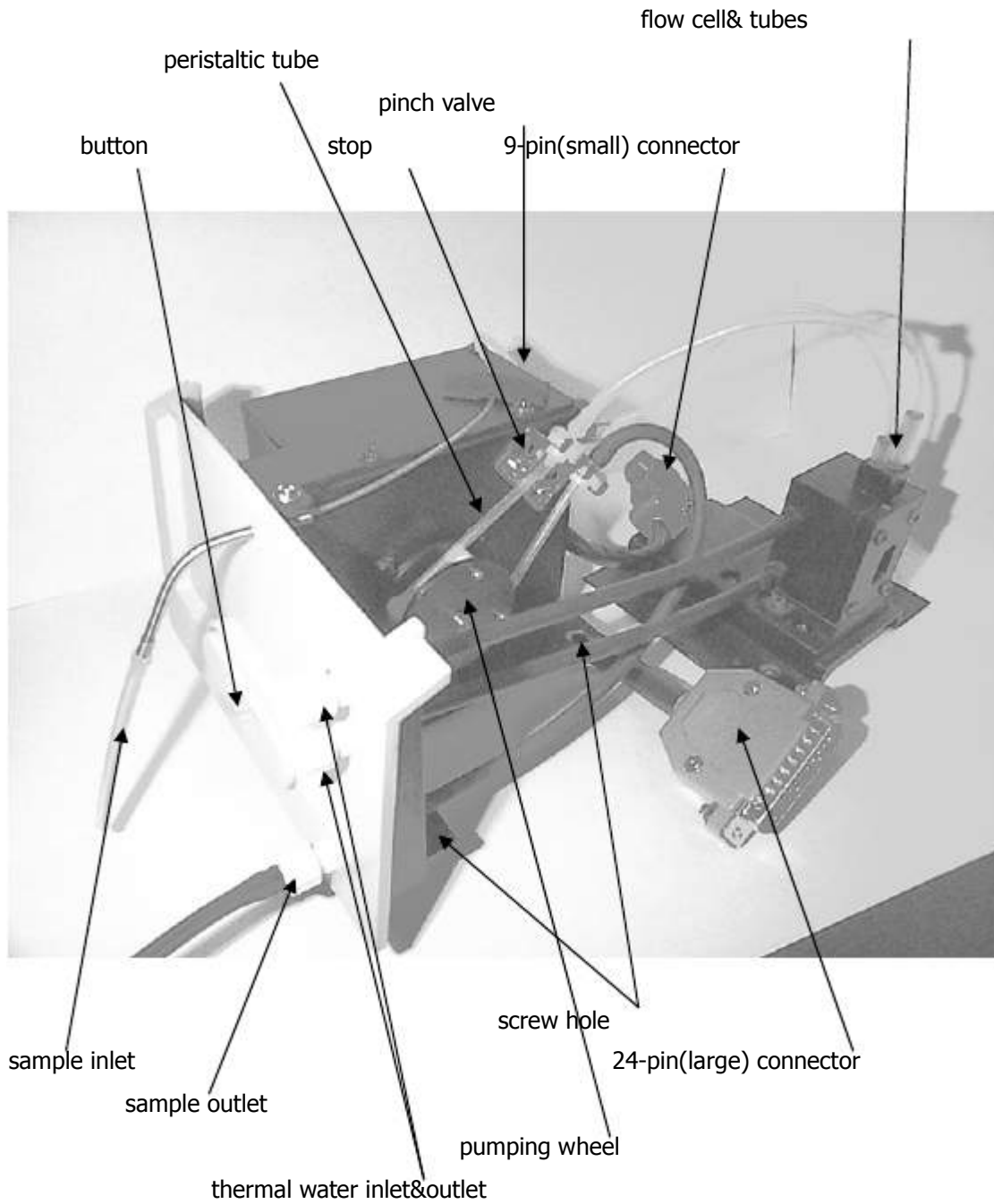

Figure 1. Sipper Assembly(with flow cell connected)

Appendix C Setting of usb serial port

If your Windows(XP/98SE) PC has USB ports only, please install the attached USB to RS232 driver on PC. Connecting the USB to RS232 cable between PC and the machine, then power it up. Please set up your Windows(XP) computer as follow.

Under '**Systems Tasks**' of '**My Computer**' screen, press '**View system information**'. In System Properties, select icon '**Hardware**' and press button '**Device Manager**'(figure C-1).

In Device Manager, double click '**USB Serial Port**'(figure C-2) to enter port setting(figure C-3). Please remember the com-port number for further use. Fill in '**57600,8,None,1,None**' in those blanks. Press button '**Advanced..**' to enter advanced COM setting(figure C-4). USB transfer size is to be selected as max number(4096). Latency timer is to be smallest number(1)

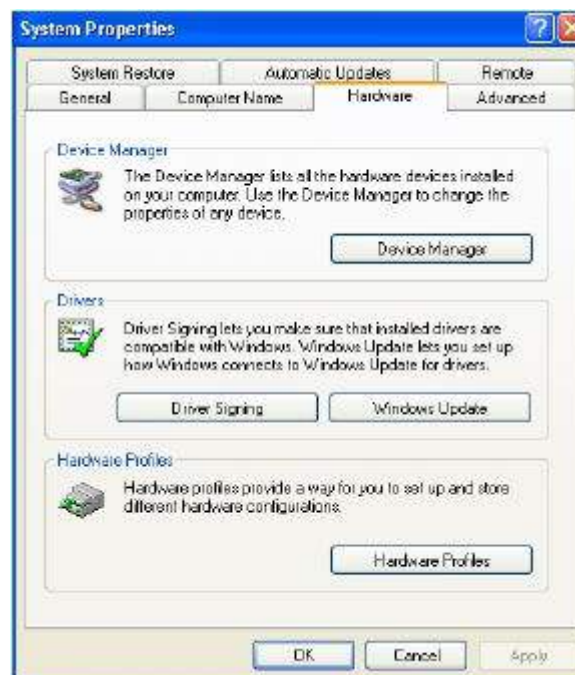

(Figure C-1)

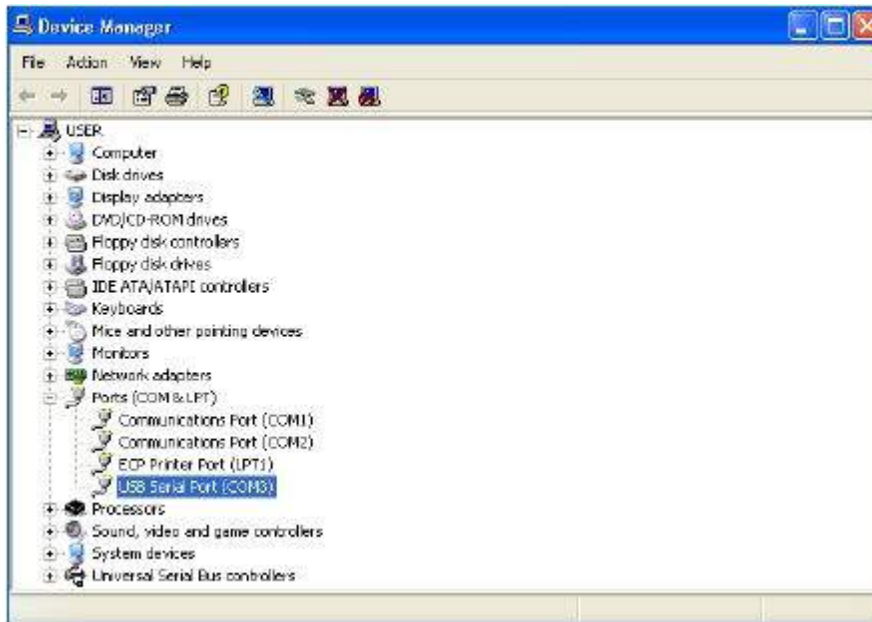

(Figure C-2)

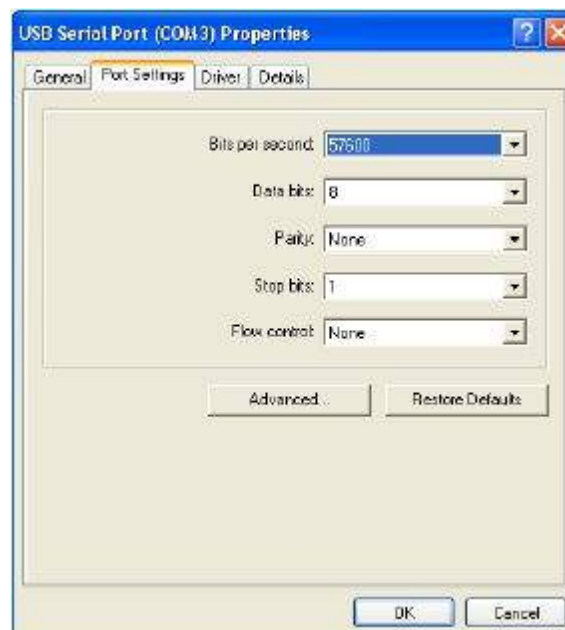

(Figure C-3)

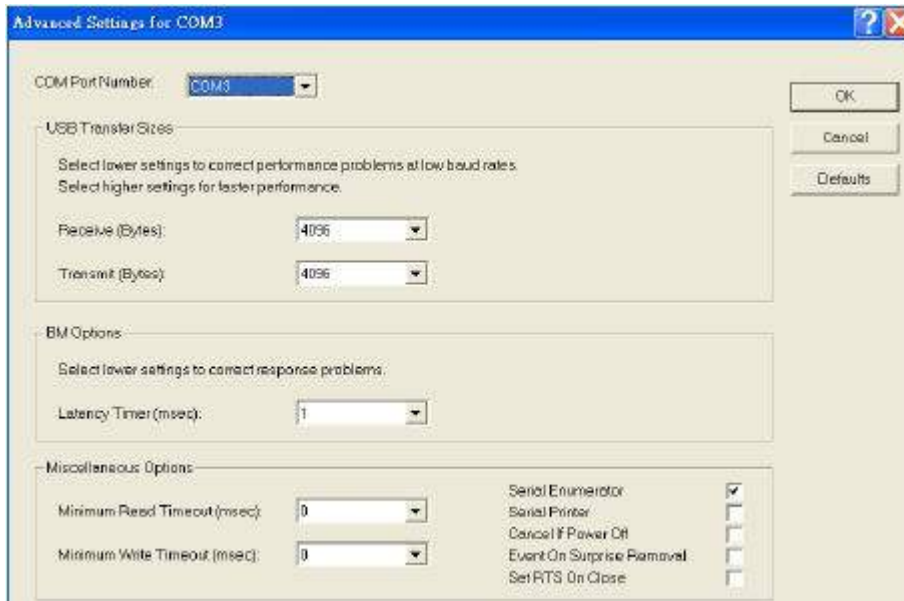

(Figure C-4)